

Contents

Warnings	Electrical regulations and important information	4
Preparation	Resistance testing	5
Preparation	How to cut, turn and position heating mesh	5
Planning	Layout and calculations	6
Planning	Insulating your substrate	7
Installation	Floor sensor installation	8
Installation	Lay out the mesh	10
Installation	Installation in irregular areas	11
Installation	Electrical connections	12
Installation	Floor finish options	13
Finalise	Important information – Dos & Don'ts	14
Finalise	Compulsory customer handover form	15

Do

- ✔ Ensure electrical circuit is protected by a suitably rated RCD and complies with local regulations
- ✔ Remove protective film before laying the underfloor heating mat and installing the floor finish
- ✔ Take care to ensure all joins are as flush as possible, using reinforcing tape if necessary
- ✔ Take care to ensure all electrical work complies with IEE 17th edition part p regulations
- ✔ Locate the thermostat in accordance with current guidelines
- ✔ Read this document in conjunction with instructions for associated accessories (eg thermostats)
- ✔ Ensure test procedures a, b & c are carried out, this is essential for completion of the warranty
- ✔ Install conduit in accordance with the instructions to facilitate replacement of the sensor probe
- ✔ Use primer before self levelling compound or tile adhesive if the manufacturer recommends it
- ✔ Protect the heat mat during installation, as this is when it is most prone to damage
- ✔ Ensure sensor conduit is positioned between 2 runs of heating cable in a representative area of the floor
- ✔ Lay wire (adhesive) side down where possible to protect cable
- ✔ Make sure all heating cable and cold tail connections are fully covered in a layer of tile adhesive or leveller and not held in position with tape

Do not

- ✘ Cut or shorten the yellow cable! This will cause a faulty circuit and potential fire hazard
- ✘ Place the cold tail connection or end termination in a recess in the floor or insulation boards and cover with tape. This causes an air pocket and leads to cable failure
- ✘ Position temperature sensor near pipes or external doorways
- ✘ Lay insulation on top of underfloor heating (ufh) or a dusty substrate. Insulation on top of UFH will reflect all the heat emitted back into the substrate
- ✘ Position temperature sensor near hot pipes or temperature influences
- ✘ Cross or overlap any heating cables
- ✘ Wire multiple mats in series
- ✘ Turn on system before adhesive or levelling compound is fully cured
- ✘ Leave boxes or furniture on heated flooring
- ✘ Strain or bend the cold tail end connections

Preparation: Performing a resistance test

Three test symbols

Be sure to check the electrical resistance reading on the cable three times; before, during and after the installation process. These test symbols throughout this guide are a reminder:



TEST A Perform Test A now and record the results on p15

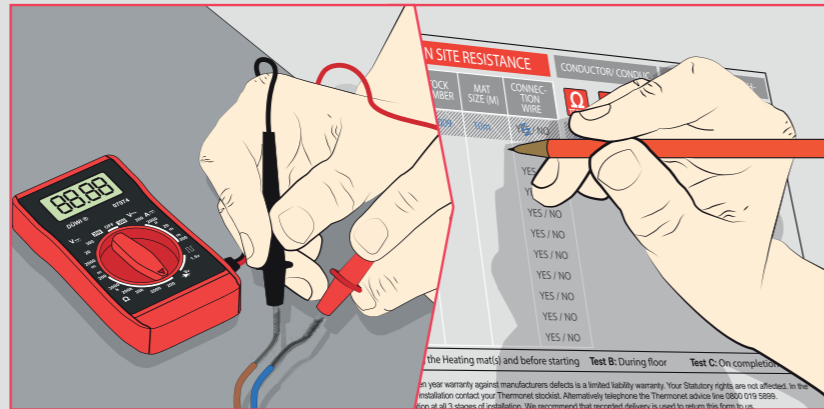

Resistance test

Test Live and Neutral, conducting the test in this way ensures total accuracy.

Record results

Write each resistance value on the customer handover form (P15) to ensure your customer can complete the warranty form online.

Cut-and-return installation explained

Every room is different and you will usually need to modify your mesh in some way to fully cover your desired heated area. The diagrams will help you to manipulate your mesh safely and avoid causing any damage during installation.

Cutting the mesh

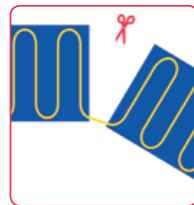

Use scissors to carefully cut the blue mesh

Turn 180°

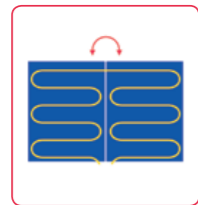

Turn the mesh through 180° parallel to the first run

Staggered 180°

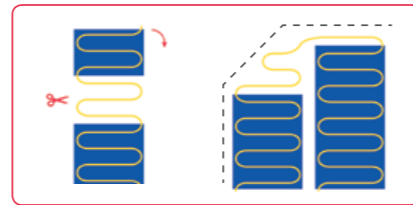

Remove the cable from the mesh and tape* in place for awkward areas such as angled walls
*Use small pieces of tape (max 10mm) and ensure there are no air voids around the cable.

Turn 90°

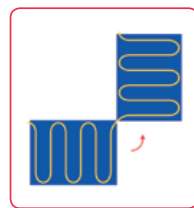

Turn the mesh through 90° for a more simple turn

Alternative 90°

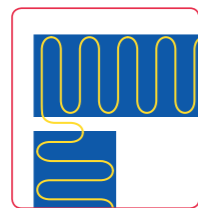

Release cable from the mesh for an alternative 90° turn

Avoid an obstacle

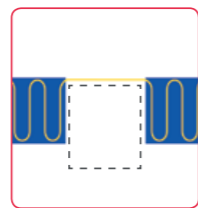

Remove the mesh to avoid permanent fixtures

Curved fan turn

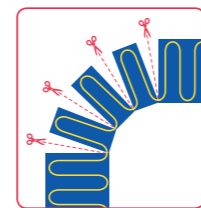

Cut mesh into sections to make a curved turn

Preparation checklist

- Read and understand test procedure
- Learn how to safely cut and turn the mat
- Learn how to adapt the mat for irregular areas

Important safety precautions

- Do not cut the yellow cable! This will void warranty and cause the mat to burn out
- All electrical work must comply with IEE 17th Edition part P regulations and IP ratings

Planning: Layout and calculations



Available floor space = _____m²

Planning avoids costly mistakes

Use the grid above to plan your installation. This will help you to produce the safest, quickest and cleanest result with as little wastage as possible.

Measure the room, if you don't already know the dimensions, and make a note of the available floor space excluding any obstacles or fixtures you might have such as sanitary ware, furniture or drainage. Use the grid to plan the mat layout making sure to include thermostat and sensor position.

Load calculations

Use the calculation below to work out the overall current draw for the ThermoSphere mesh system. If this value is over 16A you will need to have a contactor/ snubber installed by a Part P qualified electrician. Call our technical helpline if you have any questions.

Total Mat Wattage ÷ 230V = Amps (A)

Planning checklist

- Calculate available floor space
- Position thermostat & conduit correctly
- Lay out heat mat and plan using the turning guide
- Use a contactor / snubber if required

Important safety precautions

- Sensor & conduit must be positioned in between 2 runs of heating cable
- Do not position sensor & conduit near water pipes or temperature influence
- The electrical supply must always be protected by an rcd. ensure this is in place for before installation
- Do not install in areas covered by fitted furniture or permanent fixtures

Planning: Identify the substrate and lay insulation

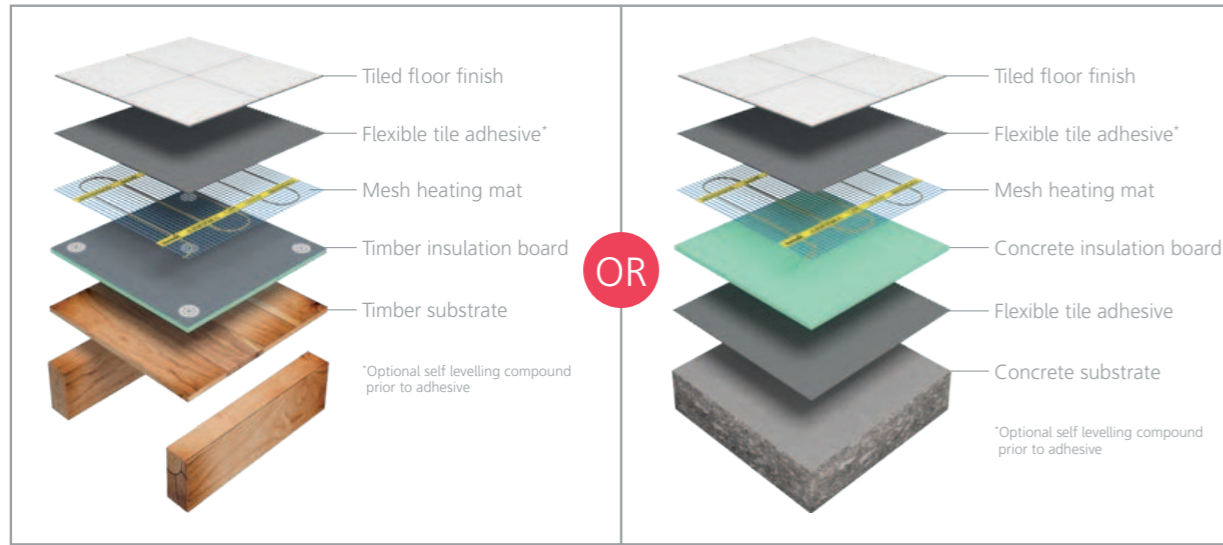

Option 1: Insulating a timber substrate

Step 1: Measure and plan the layout
First measure the floor space and calculate how many boards you'll need using the calculation below.

$$\text{A single coated board} = 1.2\text{m} \times 0.6\text{m} = 0.72\text{m}^2$$

$$\frac{\text{Floor space (M}^2\text{)}}{0.72\text{m}^2} = \text{Number of boards}$$

Step 2: Cut the insulation board to size
If required, cut the insulation board to size to suit the room layout. Insulation board can be cut very easily using a sharp blade or wood saw.

Step 3: Lay and fix Timber insulation board
Ensure the substrate is secure, clean and free of dust and loose particles. Set out the boards onto the floor space and fix in place using appropriate fixings. We recommend 32mm fixing screws, and 36mm plastic fixing washers.

PRO TIP
Make sure you have selected the right insulation type for the substrate. Effective insulation will reduce heat up times and running costs by maximising efficiency. Insulation should already be in place, if not refer to the relevant insulation board installation guide for full details

Option 2: Insulating a concrete substrate

Step 1: Measure and plan the layout
Measure the floor space and calculate how many boards you'll need using the simple formula.

$$\text{A single uncoated board} = 1.3\text{m} \times 0.6\text{m} = 0.78\text{m}^2$$

$$\frac{\text{Floor space (M}^2\text{)}}{0.78\text{m}^2} = \text{Number of boards}$$

Step 2: Cut the insulation board
If required, cut the insulation board to size to suit the room layout. Insulation board can be cut very easily using a sharp blade or wood saw. Please take appropriate care when using sharp tools.

Step 3: Spread adhesive
Ensure the substrate is secure, clean and free of dust and loose particles. Mix flexible adhesive in accordance with instructions and spread using a notched trowel creating a full bed of adhesive large enough for one board.

Step 4: Lay the insulation board
Lay the insulation board onto the adhesive taking care to squeeze out any air pockets in the adhesive. For a high quality finish make sure all boards are flush and tape over the seams using fibreglass reinforcing tape.

- Insulation checklist**
- Identify correct substrate & required insulation
 - Calculate how many boards you need
 - Install insulation according to relevant guide
 - Ensure the substrate is clean & level

- Important safety precautions**
- Ensure all air pockets are squeezed out of adhesive when laying insulation onto tile adhesive
 - Take care to ensure all joins are as flush as possible and tape together if necessary
 - Concrete insulation board will compress or puncture under low surface area impact - be careful!
 - Do not lay insulation on top of underfloor heating or an unprepared substrate

Installation: Position the conduit correctly

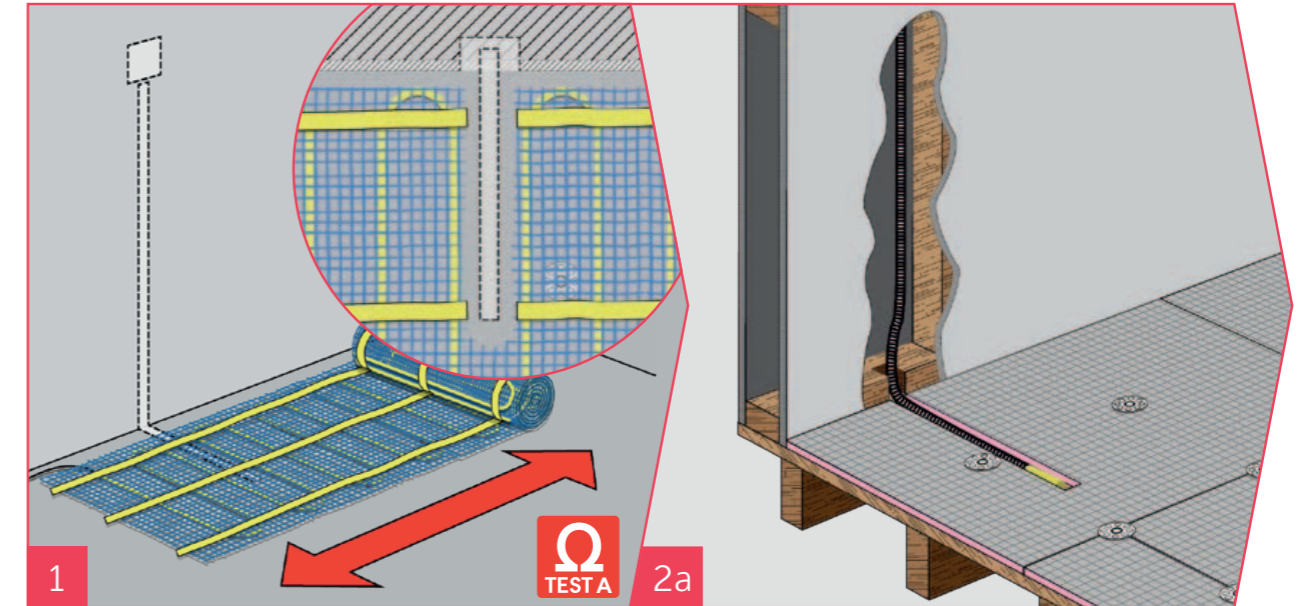

Step 1: Mark out conduit position

Referring to your plan install the back box in the required position. Trace a line vertically from the back box to the floor. Roll out the heating mesh from the start position and mark the conduit position so it lays in between two runs of heating cable.

It is important not to position the sensor conduit near any temperature influence (such as water pipes) or in a place where furniture or rugs might be placed over the sensor. This will provide an inaccurate temperature reading and affect the running costs and comfort.

After you've marked out the conduit position roll the mat away for the time being. The mesh adhesive can be reapplied up to ten times when applied to a clean, dust free substrate.

PRO TIP
The sensor probe is supplied with 2m of connection cable. The ideal thermostat height is 1.3m from the floor.

TEST A Perform Test A now and record the results on p14

- Step 1 & 2a checklist:**
- Test circuit resistance & record results - Test A
 - Keep the yellow cap on the conduit
 - Check coldtail will reach the back box
 - Put mat back into box to avoid damage

Step 2a: Timber substrate & cavity wall

Chase the marked out area on the solid wall making a channel 12mm wide and 12mm deep into the insulation board, if installed. This channel can also be recessed into the timber floor boards themselves using a router.

Position the conduit into the back box and feed it down through the wall cavity and into the channel in the floor.

PRO TIP
Use the sensor conduit provided to facilitate sensor replacement if ever needed without the need to remove tiles or floor covering.

PRO TIP
Sensors and conduit are flexible so you can adjust it if the thermostat position does not line up between two runs of heating cable.

IMPORTANT INFORMATION
Do not place the cold tail connection or end termination in the wall/ floor cavity or in a recess in the floor/insulation boards covered with tape. This causes an air pocket and leads to cable failure which voids the warranty.

Ensure 100% of the heating cable, cold tail connection and end termination is fully embedded in a layer of flexible tile adhesive or levelling compound.

- Important safety precautions**
- It is important to check for other heat sources such as central heating pipes or lights below the floor as this can alter readings
 - Put mat away during conduit installation to avoid damage
 - The sensor wire must not cross or touch any yellow heat mat wires. also the sensor must be placed in conduit to facilitate removal

Installation: Installing a conduit

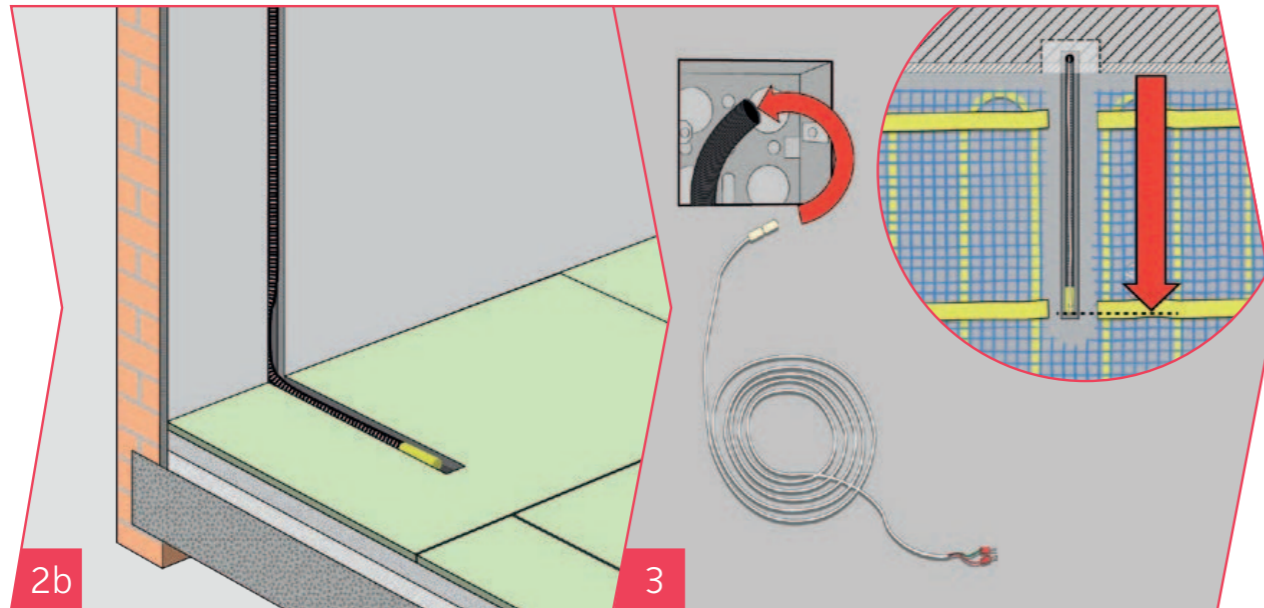

Step 2b: Concrete substrate

Chase the marked out area on the solid wall making a channel 12mm wide and 12mm deep directly into the wall and concrete substrate. Please wear adequate eye protection.

Position the conduit into the back box and feed it down through the wall channel and into the channel in the floor.

PRO TIP

Chase a slight groove into the substrate to recess the cold tail. This will make tiling or screeding much easier and provide a neater finish.

Step 3: Insert the sensor probe into the conduit

Now feed the sensor probe cable down into the conduit ensuring to push it right to the end of the cap.

This will help to provide the most accurate reading.

PRO TIP

The sensor probe can be shortened or lengthened. If you need to cut the sensor probe you must only cut the end with the exposed wires - not the end with the plastic end cap. Please note: The sensor probe is not polarity sensitive

IMPORTANT INFORMATION

Do not place the cold tail connection or end termination in the wall/ floor cavity or in a recess in the floor/insulation boards covered with tape. This causes an air pocket and leads to cable failure which voids the warranty.

Ensure 100% of the heating cable, cold tail connection and end termination is fully embedded in a layer of flexible tile adhesive or levelling compound.

Step 2b & 3 checklist:

- Chase a groove to recess coldtail
- Install sensor probe correctly
- Push sensor probe to the end of the conduit
- Ensure the cap is on the conduit
- Feed a conduit from your back box and along your chased area

Important safety precautions

- Do not switch on until installation is complete, you do not need a current to test the mat resistance
- Take care to avoid walking on exposed heating wires with hard footwear
- Timber and concrete substrates differ. please ensure you specify correct insulation boards
- If installing using insulation board chase the sensor probe into the insulation rather than the substrate

Installation: Lay out the heating mesh

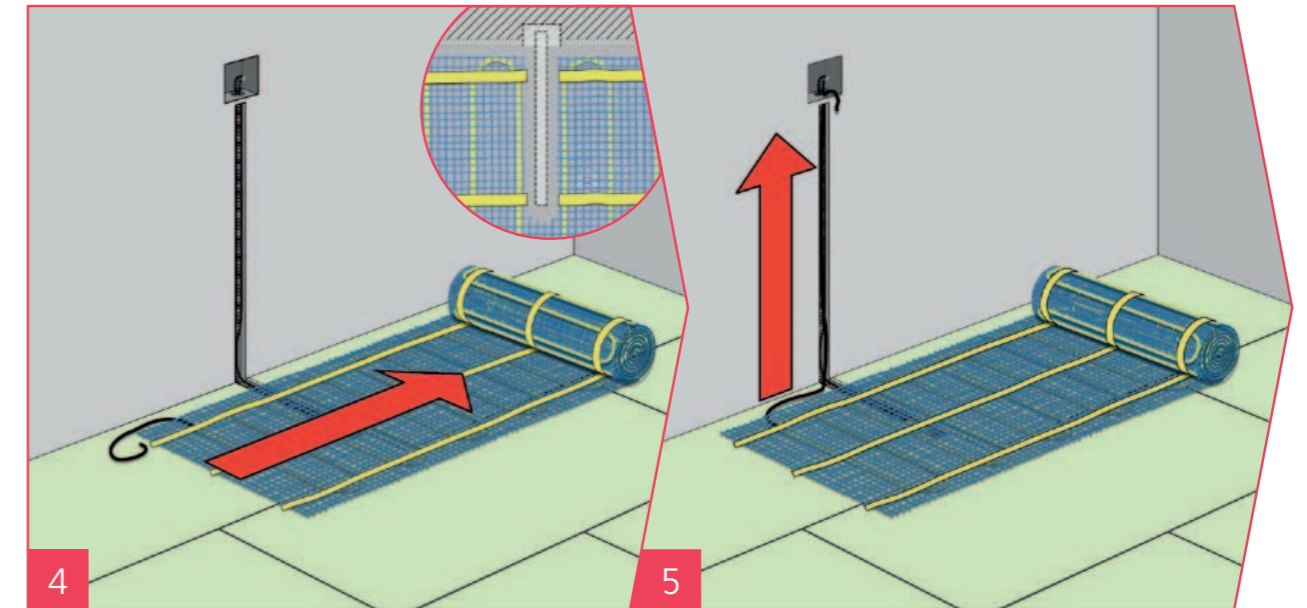

Step 4: Roll out the mesh as planned

Make sure your substrate and insulation is clean and dust free before installing your heating mesh.

IMPORTANT: Remove transparent protective film from the matting before installation.

Lay the heating mesh adhesive side down where possible. Place the heating mesh in the starting position, the same place as in Step 1, and roll it out ensuring the conduit lines up in between two runs of heating cable as planned.

PRO TIP

Allow a gap of between 50-100mm from the wall to the edge of the ThermoSphere underfloor heating mesh.

Step 5: Feed the cold tail into the cavity

Feed the cold tail up and into the channel in the wall or through the cavity. Heating mesh is a single ended product so there is no extra cable to return.

If you have not already done so now is a good time to chase a shallow channel out of the insulation or substrate to recess the cold tail into the floor slightly. This will make tiling easier.

PRO TIP

Purchase additional conduit for the cold tail to facilitate removal if required.

IMPORTANT INFORMATION

Do not place the cold tail connection or end termination in the wall/ floor cavity or in a recess in the floor/insulation boards covered with tape. This causes an air pocket and leads to cable failure which voids the warranty.

Ensure 100% of the heating cable, cold tail connection and end termination is fully embedded in a layer of flexible tile adhesive or levelling compound.

Step 4 & 5 checklist:

- Lay heating mesh wire side down where possible
- Leave gap of 50 - 100mm between mesh & wall
- Feed cold tail up wall to back box

Important safety precautions

- Lay wire and adhesive side down for protection where possible to protect heating cables
- Ensure substrate is clean, stable and dust free. remove protective film before laying heating mesh

Installation: Lay out the mesh in irregular areas

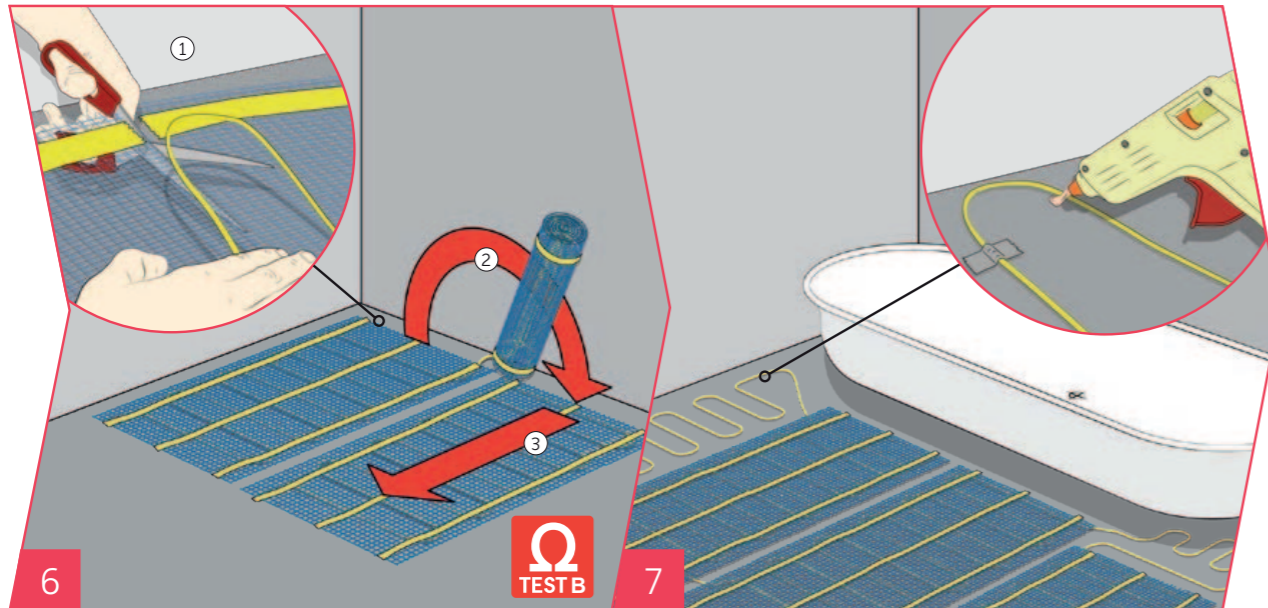

Step 6: Simple turns

When you reach the end of a run, a simple turn can be achieved by cutting across the blue mesh with scissors or a stanley knife. Turn the mat 180° and roll it out parallel to the first run.

- ① Cut the blue mesh, **never cut the yellow cable!**
- ② Turn through 180°
- ③ Continue rolling out the mat cable adhesive side down

More simple turns....

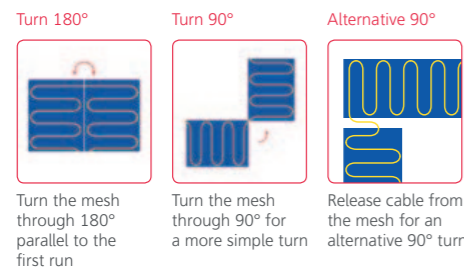

Turn the mesh through 180° parallel to the first run
 Turn the mesh through 90° for a more simple turn
 Release cable from the mesh for an alternative 90° turn

Step 7: Irregular areas

Heating mesh will not always fit the spaces around irregular shapes like a bath, toilet or sink pedestal. In this case simply remove the cable from the mesh and arrange in loops to cover the area. Use a minimum cable spacing of 50mm and fix in place using a hot glue gun or strong tape.

Do not place directly under permanent fixtures or furniture such as under pedestals or vanity units. Allow 50 - 100mm spacing between heating cables and permanent fixtures.

Solutions for irregular areas...

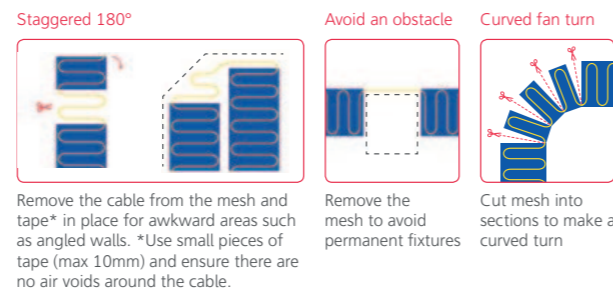

Remove the cable from the mesh and tape* in place for awkward areas such as angled walls. *Use small pieces of tape (max 10mm) and ensure there are no air voids around the cable.
 Remove the mesh to avoid permanent fixtures
 Cut mesh into sections to make a curved turn

TEST B Perform Test B now and record the results on p15

- Step 6 & 7 checklist:**
- Test circuit resistance & record results - test b
 - Turn mat using simple guide
 - Fix loose cable using glue gun or tape

- Important safety precautions**
- ⚠ Do not cut the yellow heating cable
 - ⚠ Do not staple or lay insulation on top of under floor heating

Installation: Final connections

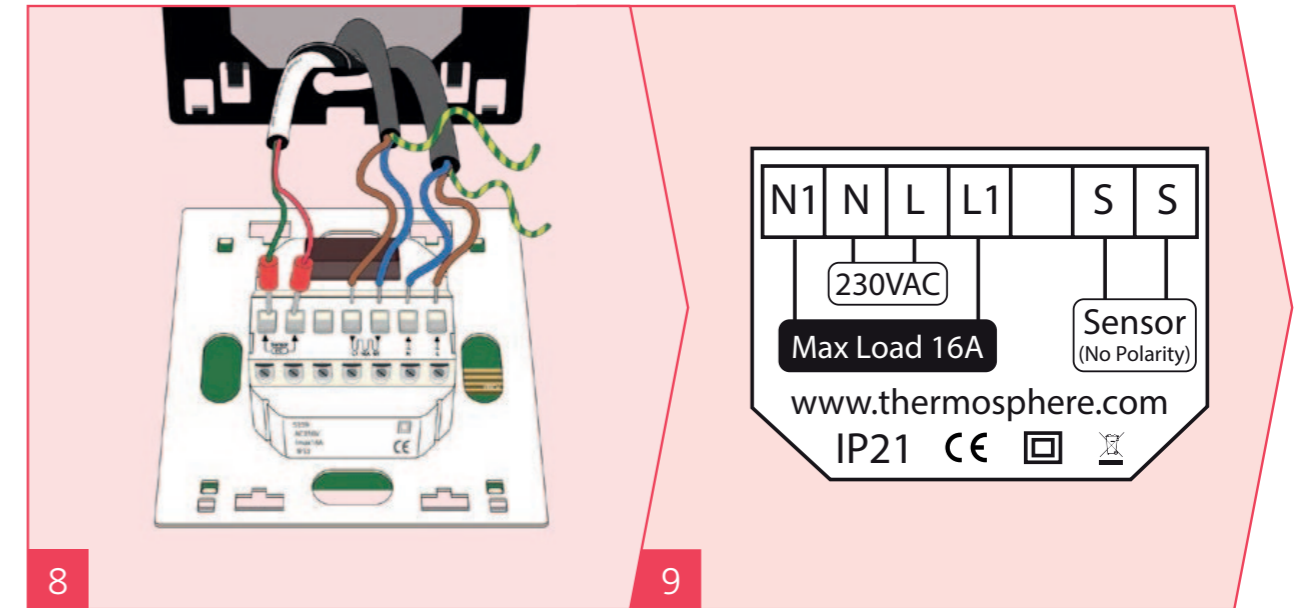

Step 8: Thermostat installation

Your thermostat may require a different wiring diagram. Please consult the relevant installation guide for full details.

1. Connect sensor probe - No polarity
2. Connect heating cable cold tail
3. Connect mains supply
4. Fix thermostat to back box
5. Fit the face plate

Step 9: Detailed wiring schematic

Position the cables as shown on your particular thermostat's specific wiring diagram and tighten the tension screws.

- ① Sensor probe cable
 - ② Thermonet mat cold tail
 - ③ Power supply
- ✓ **PRO TIP**
 Use automatic wire strippers to bare the wires. This will ensure a good amount of wire is exposed to ensure a safe connection.

⚠ ThermoSphere thermostat sensor probes are not polarity sensitive. Either colour wire can be connected to either of the sensor probe ports on the back of your thermostat.

- Step 8 & 9 checklist:**
- Wire thermostat to an RCD
 - Connect wiring in accordance with relevant wiring diagram
 - Install thermostat securely to back box and earth

- Important safety precautions**
- ⚠ Diagrams and installation steps above are for illustrative purposes only
 - ⚠ Consult wiring diagram in relevant thermostat installation guide before installation

Installation: Flooring options

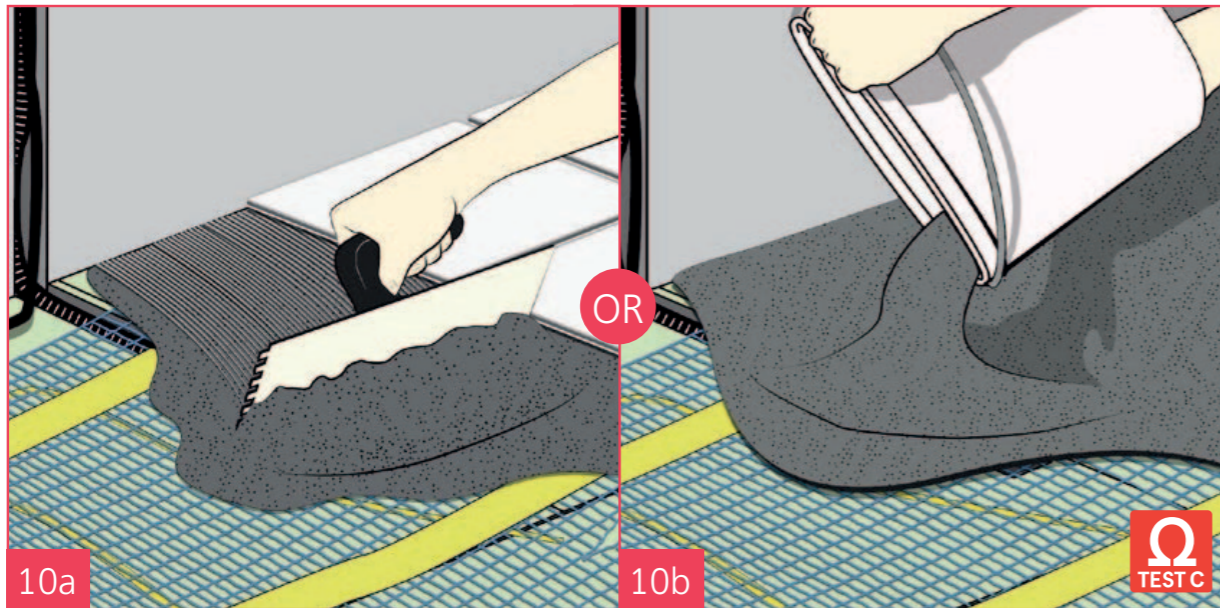

Step 10a: Flooring with tile adhesive

You can simply tile directly over ThermoSphere underfloor heating but take extra care not to damage the yellow cable in any way. Always laying the mat wire (adhesive) side down will help to avoid this.

Tile the floor using a flexible tile adhesive, we recommend ThermoSphere tile adhesive and grout in accordance with industry standards and manufacturer guidelines. (Plastic trowel recommended). To allow the flexible tile adhesive to fully cure, you must wait two weeks, unless otherwise stated by the manufacturer. You can now switch your new ThermoSphere system on.

PRO TIP

The heating may be slow to react at first, especially if installed on a new screed floor or in a new building. Start by setting the floor temperature at approx 18°C and build up by 1°C per day until the desired temperature is reached.

Remove protective film before laying the floor finish!

Other compatible floor finishes:

- ✓ Ceramic tiles
- ✓ Porcelain tiles
- ✓ Natural stone tiles
- ✓ Marble and slate tiles

Step 10a & 10b checklist:

- Lay mat wire side down where possible
- Use a solid bed of flexible adhesive used for tiling
- Lay self levelling compound prior to floor finishes

Step 10b: Flooring with self levelling compound

If you plan to install carpet, vinyl or wood flooring over a ThermoSphere installation you must first lay a bed of at least 10mm self levelling compound such as ThermoSphere levelling compound. Please refer to the relevant installation guide for details.

Lay the flooring according to the manufacturer's instructions. Please refer to manufacturer's guidelines for drying times before turning on the heating system, this is usually around 2 weeks. You can now switch your new ThermoSphere system on.

Remove protective film before laying the floor finish!

Other compatible floor finishes:

- ✓ Engineered laminate floor
- ✓ Carpet
- ✓ Vinyl & cork
- ✓ Karndean and Amtico
- ✓ Resin safety floors

TEST C Perform Test C now and record the results on p15

IMPORTANT INFORMATION

Do not place the cold tail connection or end termination in the wall/ floor cavity or in a recess in the floor/insulation boards covered with tape. This causes an air pocket and leads to cable failure which voids the warranty.

Ensure 100% of the heating cable, cold tail connection and end termination is fully embedded in a layer of flexible tile adhesive or levelling compound.

Important safety precautions

- ⚠ Take care not to snag yellow cables. Use a plastic trowel
- ⚠ Use a suitable flexible tiling adhesive or self levelling compound

Electric underfloor heating installation Do's & Don'ts

- ⚠ You must ensure that the entire cold tail joint (the join between the heating element and the flexible power supply lead) is fully encapsulated in tile adhesive or levelling compound
- ⚠ Please ensure that the end termination (the join at the end of the heating cable) is also fully encapsulated in tile adhesive or levelling compound
- ⚠ The cold tail joint and end termination must not be placed into a cut out of insulation or sub floor and covered with tape. This can cause an air pocket which can cause the cable to over heat and fail over time
- ⚠ The entire heating element must be encapsulated in tile adhesive or levelling compound. The heating cable must not be held in place with tape

If you are unsure or need any help please call our team on 0800 019 5899

- ✓ Do read through the instructions in full before starting the installation.
- ✓ Do use flexible adhesives, grouts and levelling compounds.
- ✓ Do test the cable before tiling.
- ✓ Do be careful not to damage or dislodge the cable during tiling.
- ✓ Do make sure the cable spacing is no closer than 50mm.
- ✓ Do try to protect the heating cable before and during tiling.
- ✓ Do wait at least 7 days after tiling before turning on the system.
- ✓ Do read the separate installation and operating instructions for the thermostat.
- ✓ Do ensure that the entire heating cable, cold tail joint and end termination is encapsulated in adhesive or levelling compound under the floor.
- ✗ Do not cut the heating cable under any circumstances.
- ✗ Do not allow the heating cables to touch or cross over each other.
- ✗ Do not allow excessive traffic of any kind over the cable before tiling.
- ✗ Do not cut tiles over the heating cable.
- ✗ Do not place tools, stacks of tiles or anything heavy over the cables.
- ✗ Do not place any product over the floor covering that has a tog rating higher than 2.5.
- ✗ Do not place bean bags, cushions or fixed furniture over the heated floor covering.
- ✗ Do not place heating cables within 100mm of the edge of the room or any other obstacle.
- ✗ Do not turn on the heating cable or mat while it is rolled up.
- ✗ Do not bend the cold tail connection or end termination at any point.