

Luxury 10mm Screen Installation Instructions

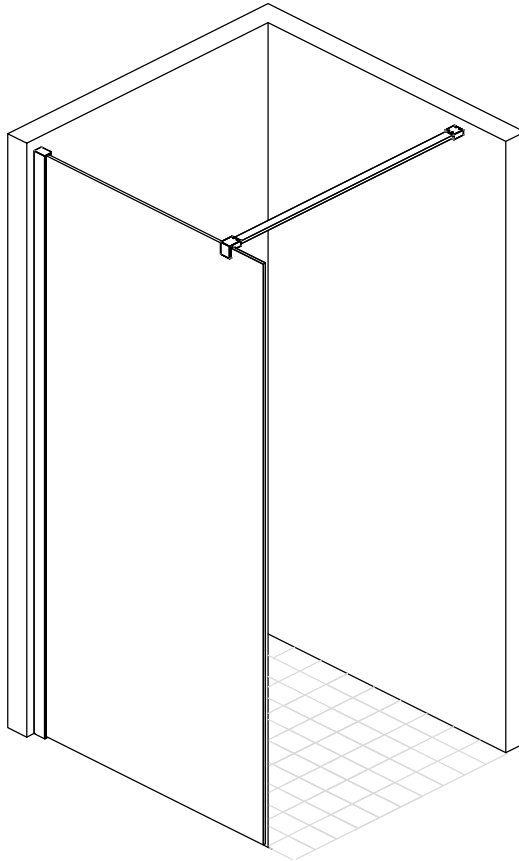

C0371-A00-01

1

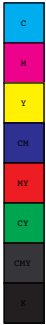



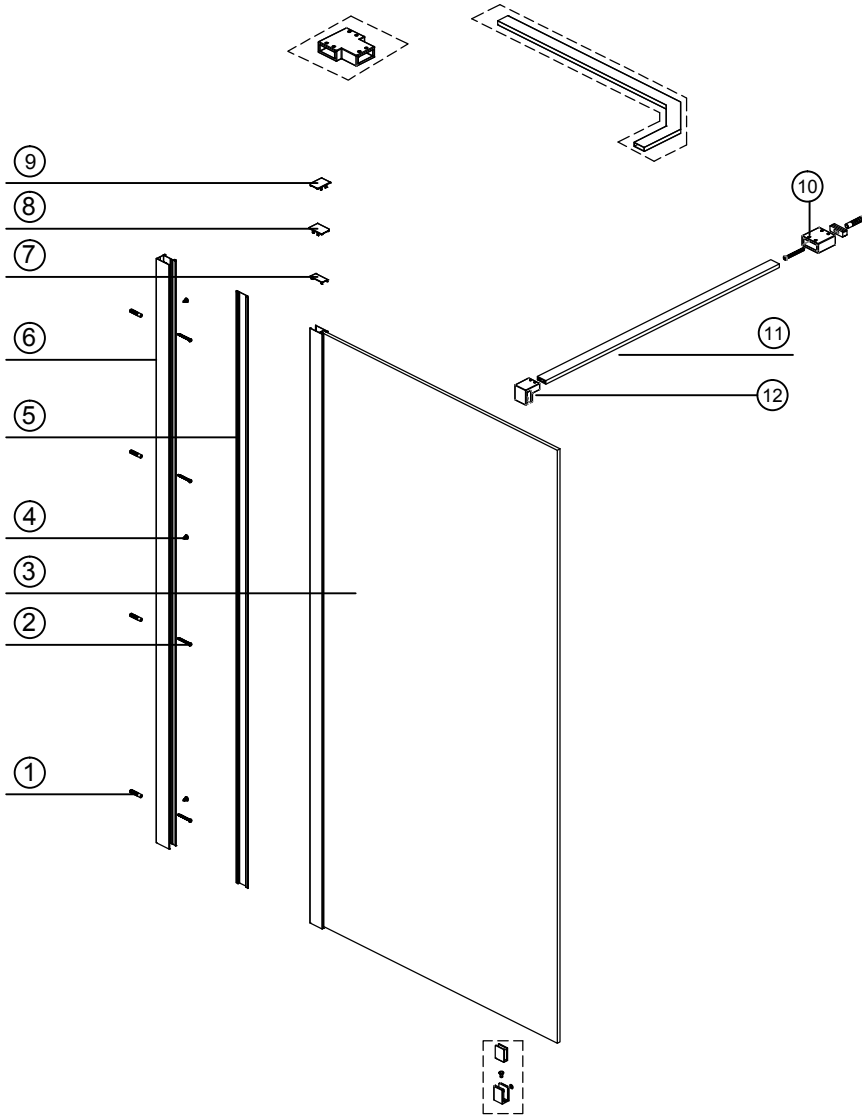



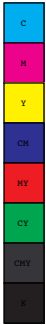



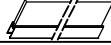

Parts Identification





----- Optional extra part















Components List

N0.	Drawing	Description	Qty
1		Wall plug	4
2		No8x1 3/4" Pozi Pan Screw	4
3		Fixed panel	1
4		No8x 3/8" Pozi Pan Screw	3
5		Profile cover	1
6		Wall Profile	1
7		Fixed Panel Cap	1
8		LH Wall profile Cap	1
9		RH Wall profile Cap	1
10		Wall Bracket	1
11		Bar	1
12		Glass Bracket	1

Optional extra part

A		Tee piece	1
B		Parallel Arm	1
C		Foot	1

Tools required

Drill Bits  3mm dia. HSS	Screw driver 	Drill 	Level 	Mallet 	Pencil 
Silicone 	Tape 	Allen Key 	Knife 	saw 	MASONRY DRILL BIT BIT Ø8mm 

Things to check before you start

*Check that the wet floor / tray has been installed correctly and that it is level, tiled down onto and sealed to the manufacturer guidelines.

*check

*Ensure the product is fitted to a non-porous surface ie. tiled and that the shower area is water proof. Check that the wall surface is flat.

*Unpack and check the product is complete and undamaged.

*Please check you are happy with the product before installing it.

*Fixings are supplied for solid walls only. Ensure that the correct fixings are used for the wall type if in doubt seek professional advice

*Ensure the area is clean, dry and dust free.

*Read the instructions in full.

*Have the correct tools available, see "Tools Required"

*Please dispose of all packaging with due regard to the environment.

Safety

*For domestic use only.

*Handle all glass with care - support on cardboard to avoid risk of breakage.

*When drilling walls check first for hidden pipes and cables.

*All glass is toughened –it cannot be reworked or replaced by ordinary glass.

*Use safety eyewear when drilling.

*Use safety eyewear when handling glass.

***DO NOT** drill through glass.

*Keep all small parts away from children.

*Plastic bags are dangerous. To avoid danger of suffocation or choking all plastic bags should be kept away from babies and children, and disposed of correctly after use.

*Care and Maintenance

Use clean cloth or wiper blade to remove water droplets after use

Use only soapy water and a clean damp cloth to clean the surface of the product, wipe dry after with clean dry cloth

NEVER USE solvents, scourers, abrasive solutions, bleach, acidic solutions, string detergents, aggressive chemical cleaners or solvent type cleaning solutions on this products.

*Technical Specification

This product uses toughened glass that conforms to EN12150

This product has 25mm adjustment for out of square walls

*Guarantee

Products that have not been stored, assembled, fitted correctly or not maintained in line with 'Care and Maintenance', we will not accept responsibility under the Guarantee.

If product is damaged or becomes defective due to modification, neglect, misuse we will not accept responsibility under the Guarantee.

Product damaged by accidently, willfully or due to an act of God we will not accept responsibility under the Guarantee

Products not installed in accordance to this instruction leaflet.

Product installed with known fault that was evident prior to installation.

*Fitting Tips

When drilling into tiles use masking tape to avoid drill slipping.

Installation

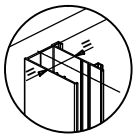

! When fitting with foot, please see foot installation instruction

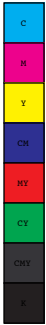
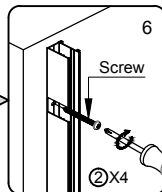
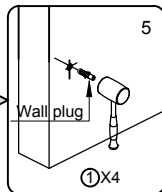
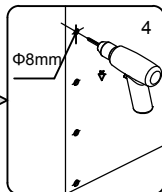
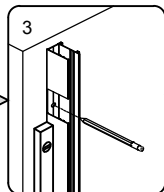
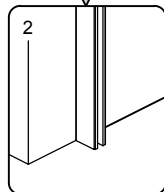
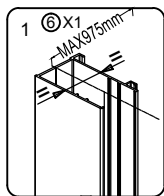
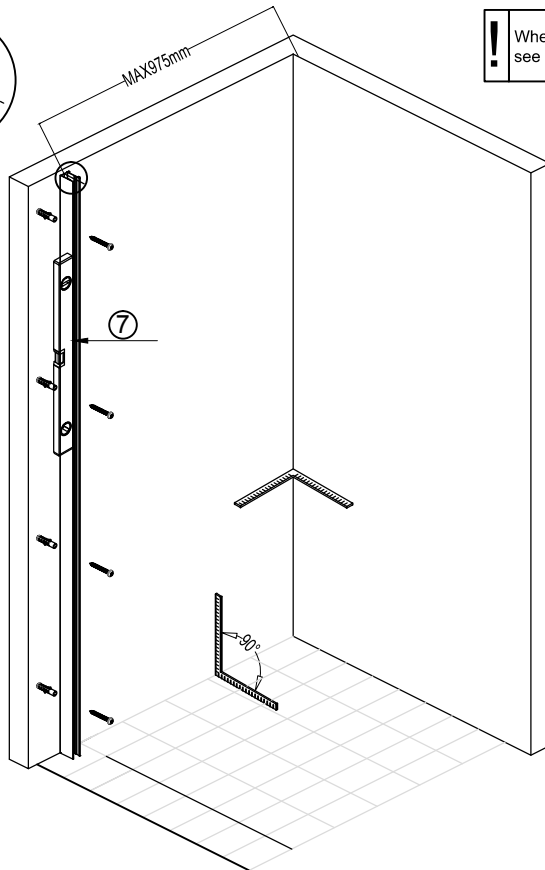

Installation

! Take care when handling glass as not to strike or damage floor.

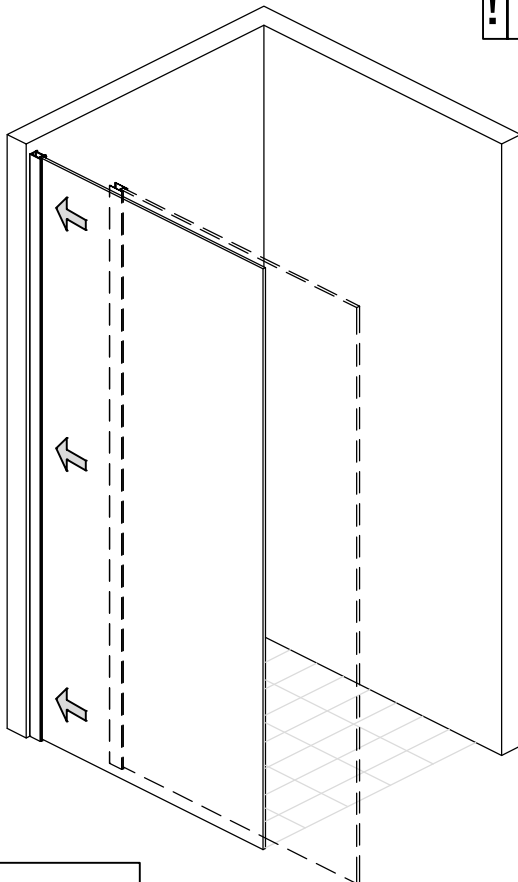

! Easy Clean label to be on inside of enclosure

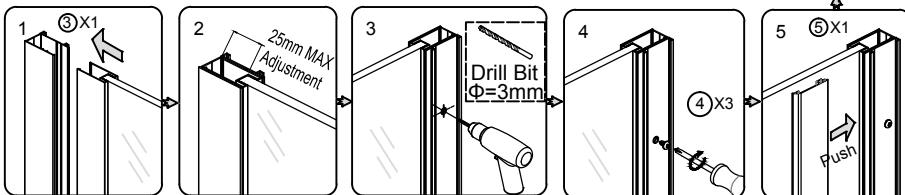

Installation

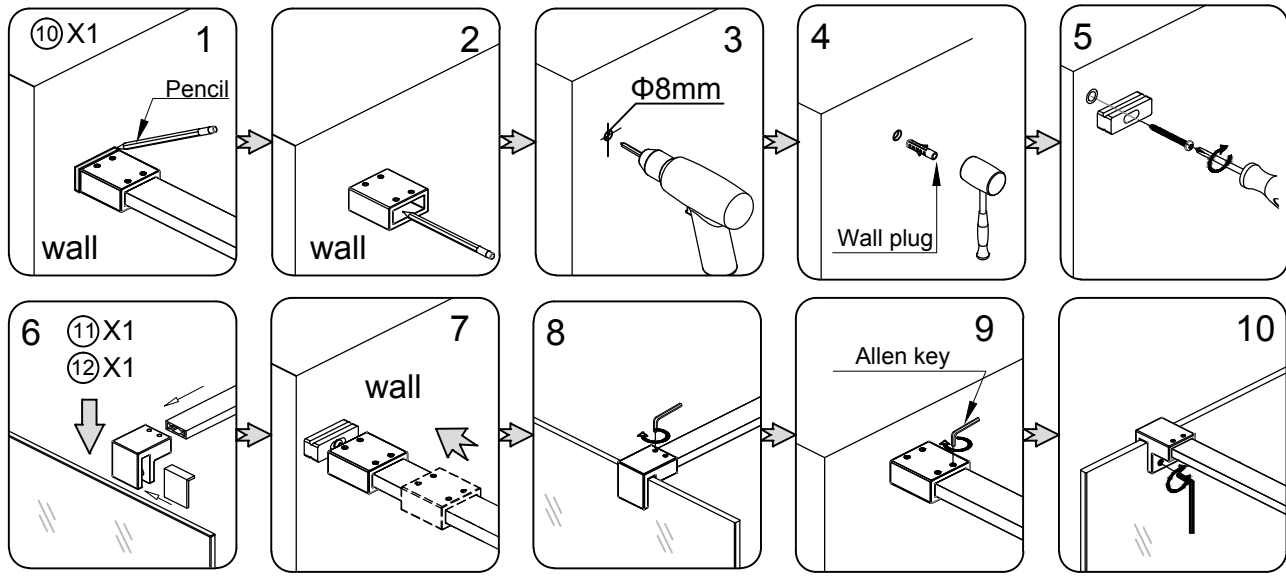
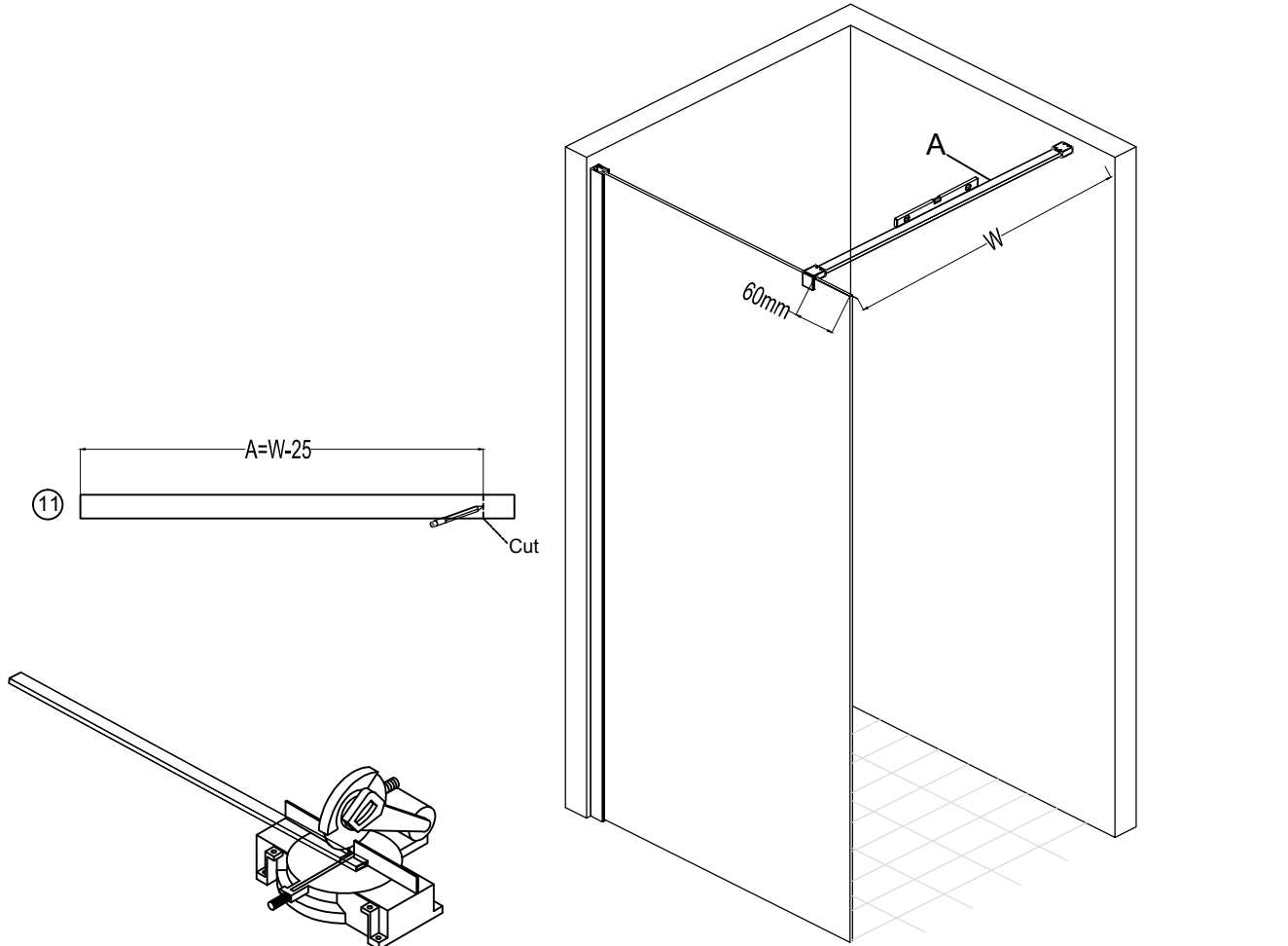

Installation

! Apply silicone between wall and wall channel on outside of product, optional apply silicone between floor and glass.

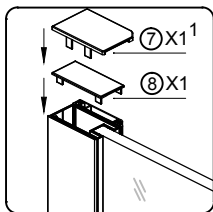
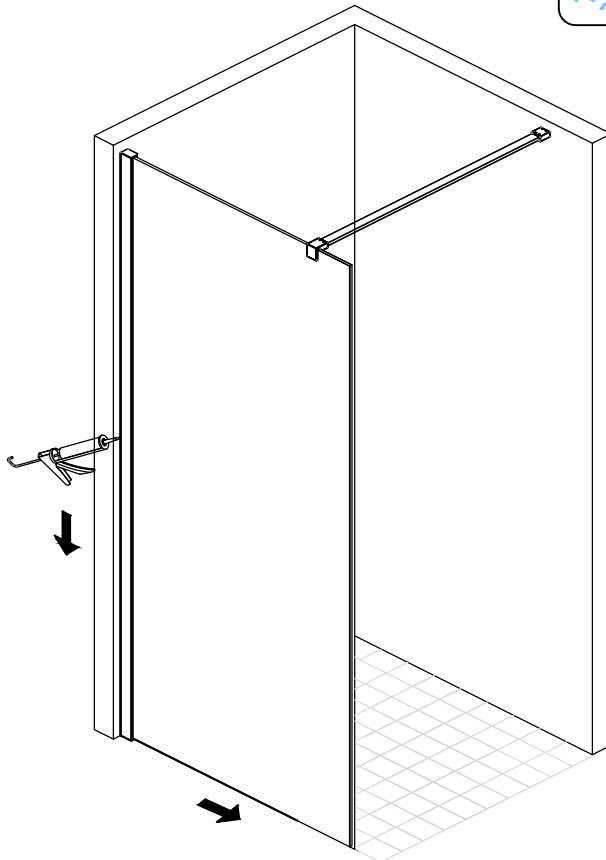

if profile on left hand

or

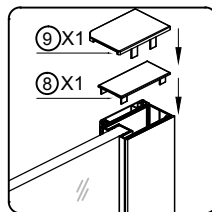

if profile on right hand

