

**INSTALLATION INSTRUCTION**  
**New Luxury Quadrant Shower**

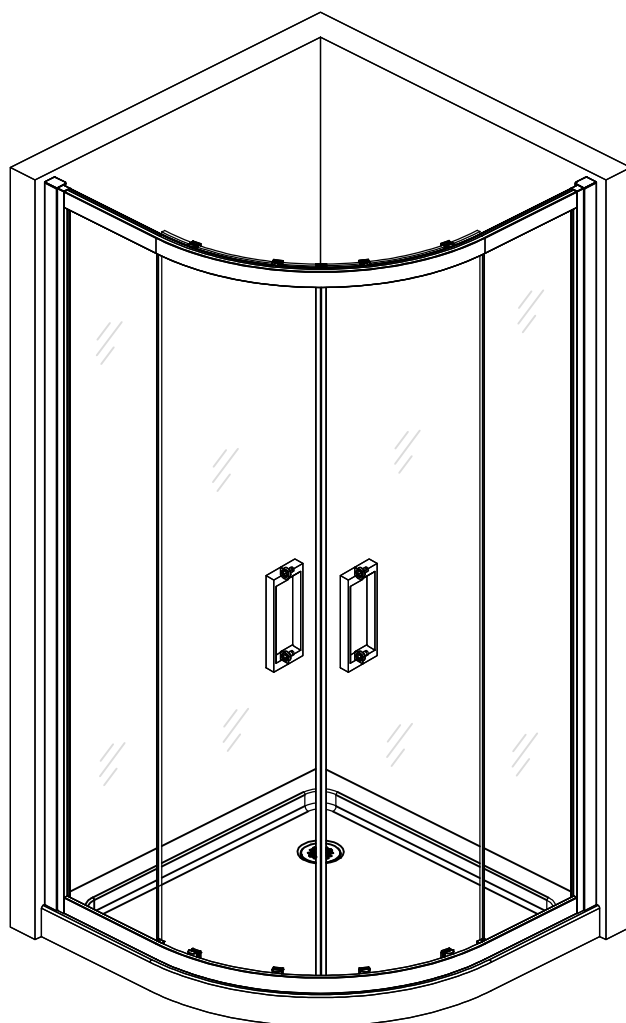

If you need further help please contact your local depot [www.ctb.co.uk](http://www.ctb.co.uk)





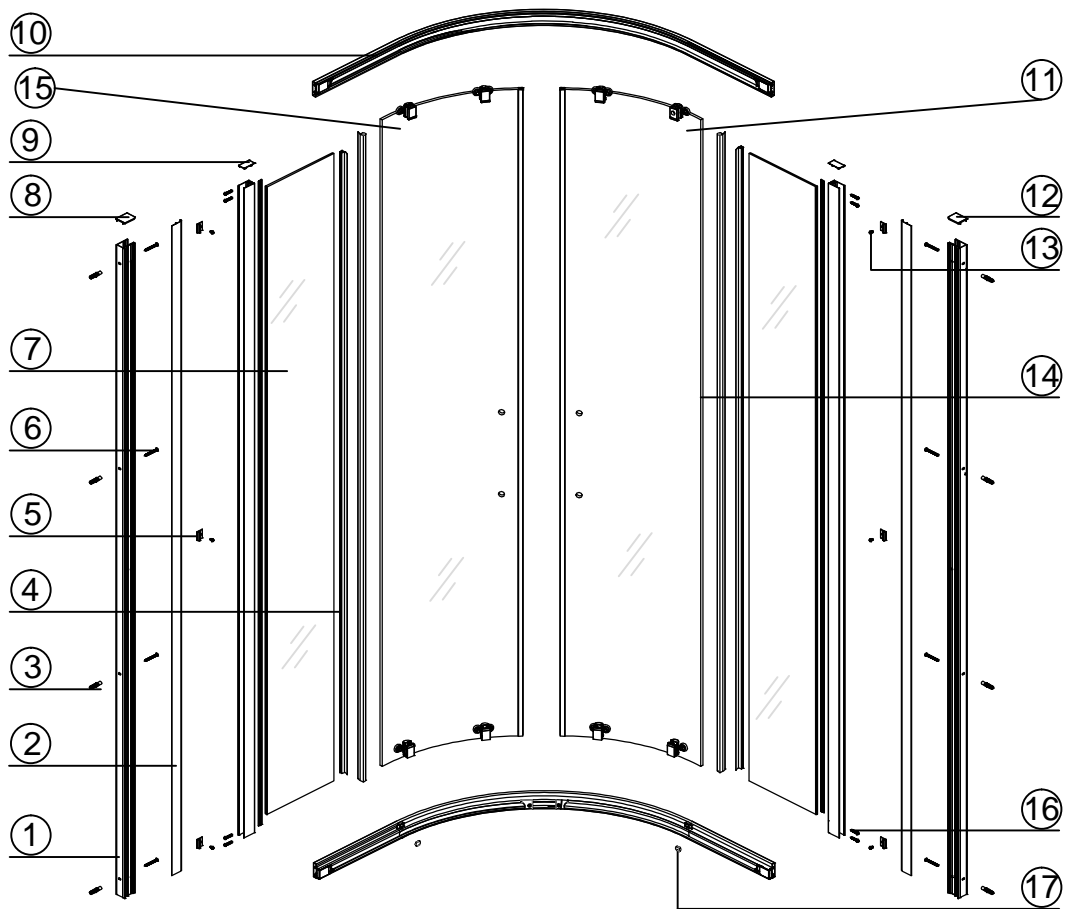











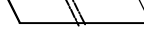

## Parts Identification

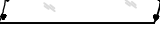

If you need further help please contact your local depot [www.ctb.co.uk](http://www.ctb.co.uk)

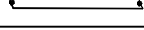











## Components List

NO.	Drawing	Description	Qty
1		Wall Profile	2
2		Profile Cover Strip	2
3		Wall Plug	8
4		Fixed Panel Seal (Short Length)	2
5		Cover Strip Clip	6
6		No8x1 3/4" Pozi Pan Screw	8
7		Fixed Panel Glass	2
8		Wall Profile RH Cap	1
9		Profile Cap	2
10		Rail	2
11		Left Door Glass	1
12		Wall Profile LH Cap	1
13		No8x 3/8" Pozi Pan Screw	6
14		Door Seal (Long Length)	2
15		Right Door Glass	1
16		No8x 1" Pozi Pan Screw	8
17		Glass Clip Cover	4

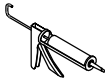
If you need further help please contact your local depot [www.ctb.co.uk](http://www.ctb.co.uk)

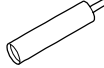

## Tools required

<p>Drill Bits</p>  <p>3mm dia. HSS</p>	<p>Screw Driver</p> 	<p>Drill</p> 	<p>Level</p> 	<p>Mallet</p> 
<p>Pencil</p> 	<p>Silicone</p> 	<p>Measuring Tape</p> 	<p>Allen Key</p> 	<p>Knife</p> 
<p>MASONRY DRILL BIT Ø8mm</p> 	<p>Goggles</p> 	<p>Glove</p> 	<p>Sealant</p> 	

## Things to check before you start

\*Check that the tray has been installed correctly and that it is level, tiled down onto and sealed to the manufacturer's guidelines.

### \*check

\*Ensure the product is fitted to a non-porous surface ie. tiled and that the shower area is water proof. Check that the wall surface is flat.

\*Unpack and check the product is complete and undamaged.

\*Please check you are happy with the product before installing it.

\*Fixings are supplied for solid walls only. Ensure that the correct fixings are used for the wall type.  
–if in doubt seek professional advice

\*Ensure the area is clean, dry and dust free.

\*Read the instructions in full.

\*Have the correct tools available, see "Tools Required"

\*Please dispose of all packaging with due regard to the environment.

If you need further help please contact your local depot [www.ctb.co.uk](http://www.ctb.co.uk)



## Safety

---

\*For domestic use only.

\*Handle all glass with care - support on cardboard to avoid risk of breakage.

\*When drilling walls check first for hidden pipes and electric cables.

\*All glass is toughened –it cannot be reworked or replaced by ordinary glass.

\*Use safety eyewear when drilling the wall.

\*Use safety eyewear when handling glass.

\***DO NOT** drill through glass.

\*Keep all small parts away from children.

\*Plastic bags are dangerous. To avoid danger of suffocation or choking all plastic bags should be kept away from babies and children, and disposed of correctly after use.

\*Care and Maintenance

- Use clean cloth or wiper blade to remove water droplets after use
- Use only soapy water and a clean damp cloth to clean the surface of the product, wipe dry after with clean dry cloth
- NEVER USE solvents, scourers, abrasive solutions, bleach, acidic solutions, strong detergents, aggressive chemical cleaners or solvent type cleaning solutions on this products.

\*Technical Specification

- This product uses toughened glass that conforms to EN12150

\*Guarantee

- Products that have not been stored, assembled, fitted correctly or not maintained in line with 'Care and Maintenance', we will not accept responsibility under the Guarantee.
- If product is damaged or becomes defective due to modification, neglect, misuse we will not accept responsibility under the Guarantee.
- Product damaged accidentally, willfully or due to an act of God , we will not accept responsibility under the Guarantee
- Products not installed in accordance to this instruction leaflet.
- Product installed with known fault that was evident prior to installation.

\*Fitting Tips

- When drilling into tiles use masking tape to avoid drill slipping.

If you need further help please contact your local depot [www.ctb.co.uk](http://www.ctb.co.uk)



## Level

1. Check shower tray is level, flat and 550 radius
2. Check walls are vertical and within shower enclosure tolerance, 20mm/side.
3. Check shower tray and walls water tight .

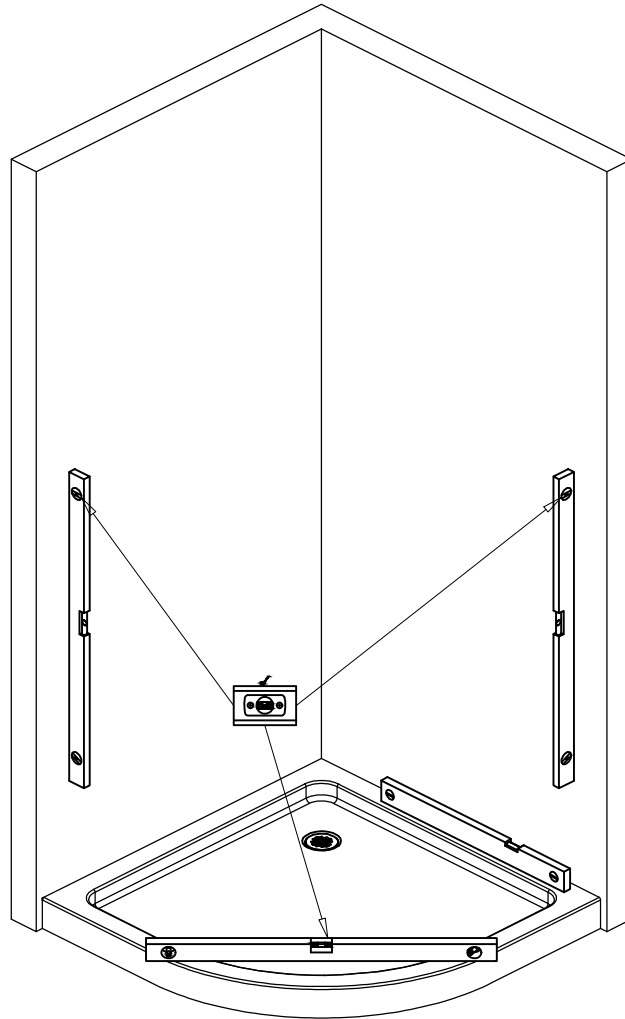

If you need further help please contact your local depot [www.ctb.co.uk](http://www.ctb.co.uk)



## Installation Quadrant Fit

Loosen screws on top and bottom rails, fit fixed panel on the same side as dampers. After assembly of frame retighten screws on rails taking care not to over tighten.

Inside View

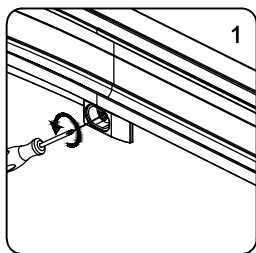

Tip:  
When inserting screws, apply a small amount of oil to the screw thread to allow easier fixing.

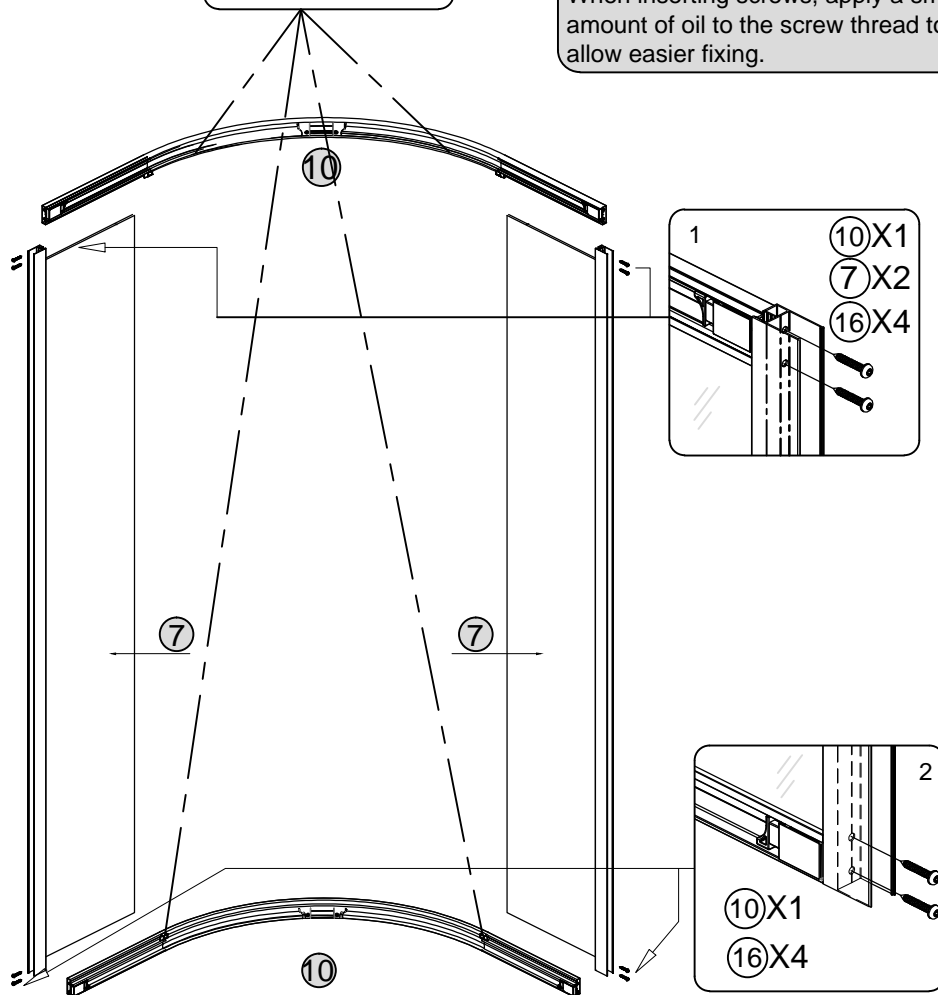

If you need further help please contact your local depot [www.ctb.co.uk](http://www.ctb.co.uk)



## Installation Quadrant Fit

Caution  
Not over tighter screw

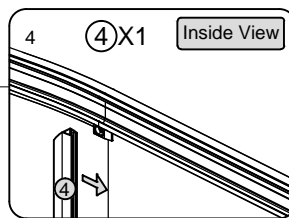
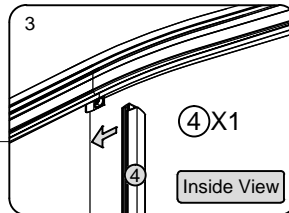
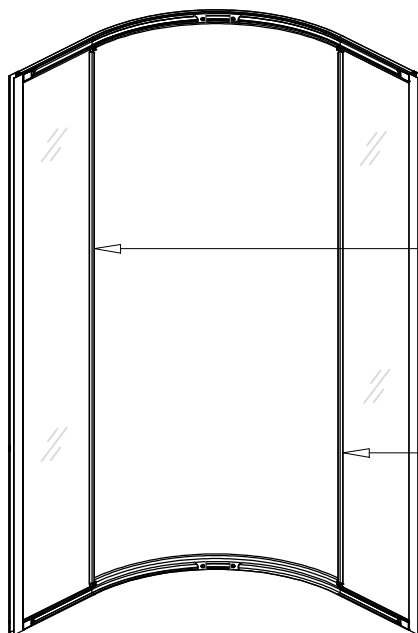
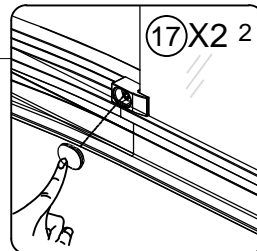
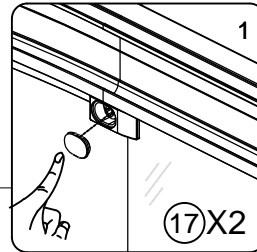
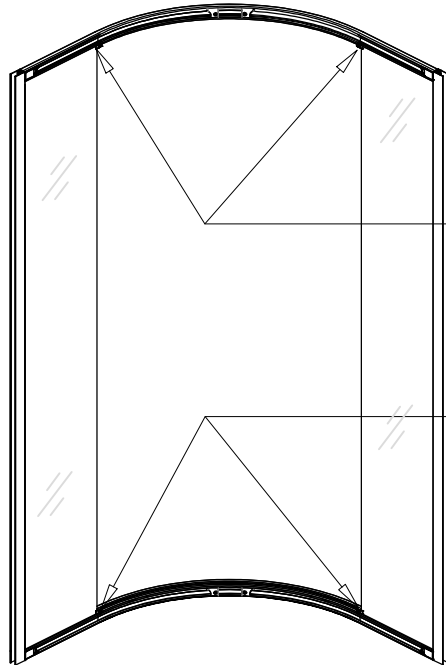

Push fixed panel seal (short)  
on to fixed panel start at  
bottom and work upwards

**!** Note:  
Two different seal lengths supplied.  
Use shorter of the two seal lengths  
for fixed panel.

If you need further help please contact your local depot [www.ctb.co.uk](http://www.ctb.co.uk)



## Installation Quadrant Fit

**\*** Tip:  
When drilling tiles, apply masking tape to surface to stop drill bit slipping.

**!** Wall plugs supplied are for solid walls only. Ensure correct wall plug for wall type is used. If in doubt seek professional advice.

**!** Position wall channel on wall. Ensure channel is vertically level and does not overhang the shower tray.

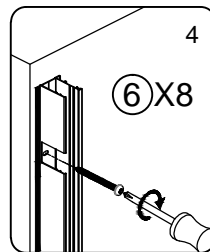
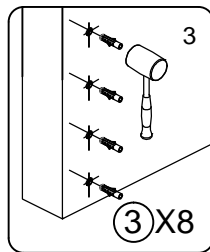
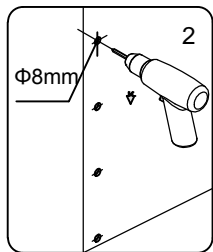
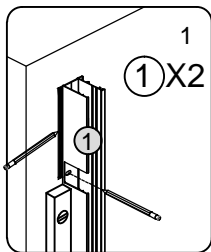
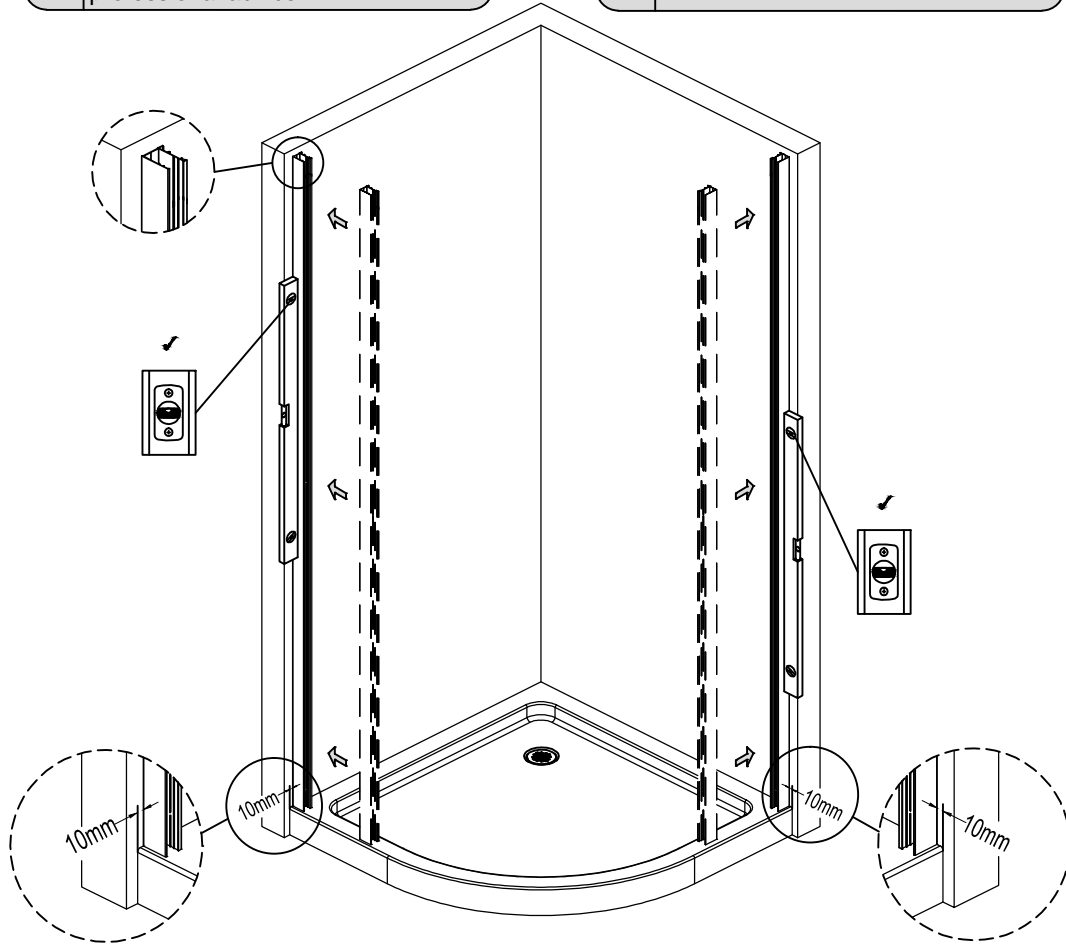

If you need further help please contact your local depot [www.ctb.co.uk](http://www.ctb.co.uk)



## Installation Quadrant Fit

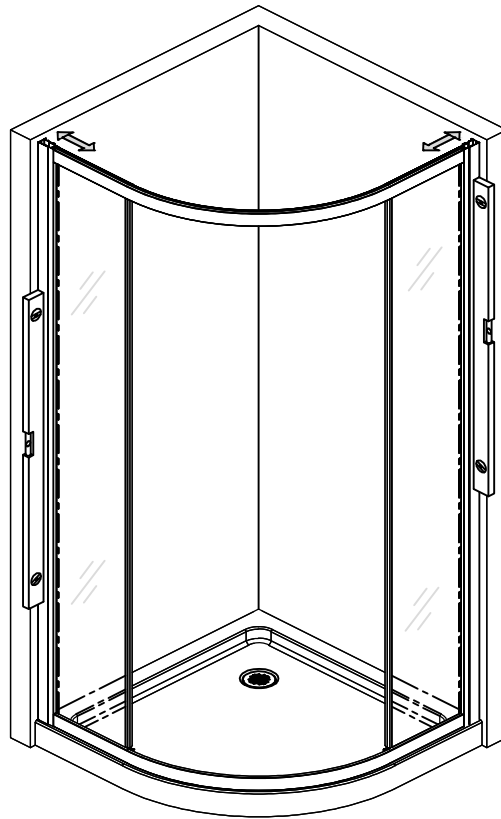
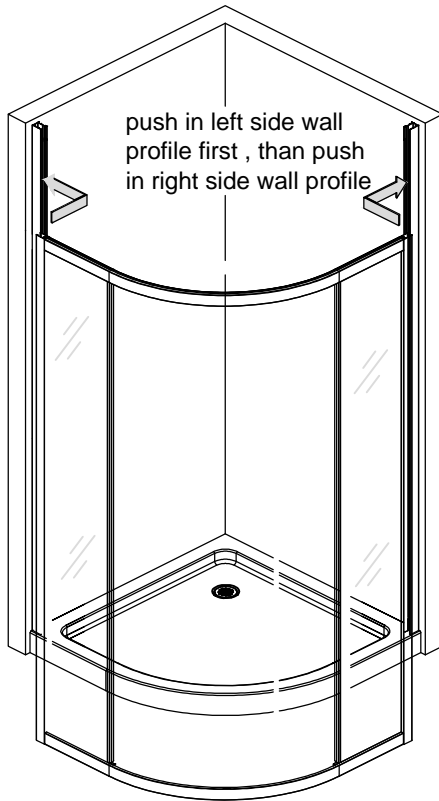

Tip:  
When positioning frame, hold frame and position bottom corners first.

Plan View

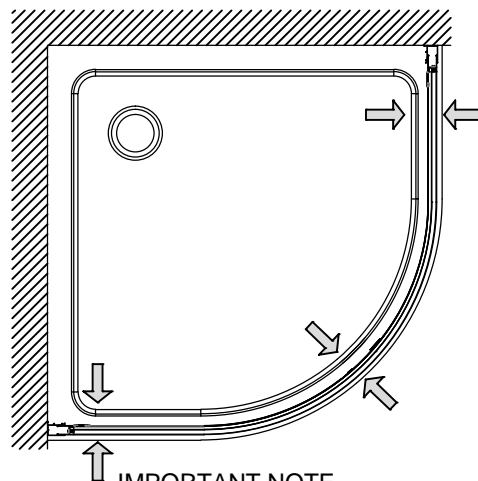

**IMPORTANT NOTE**  
Ensure fit of enclosure matches tray.  
DO NOT push frame fully into channel, allow a suitable gap to ensure adjustment and fixing.

If you need further help please contact your local depot [www.ctb.co.uk](http://www.ctb.co.uk)



## Installation Quadrant Fit

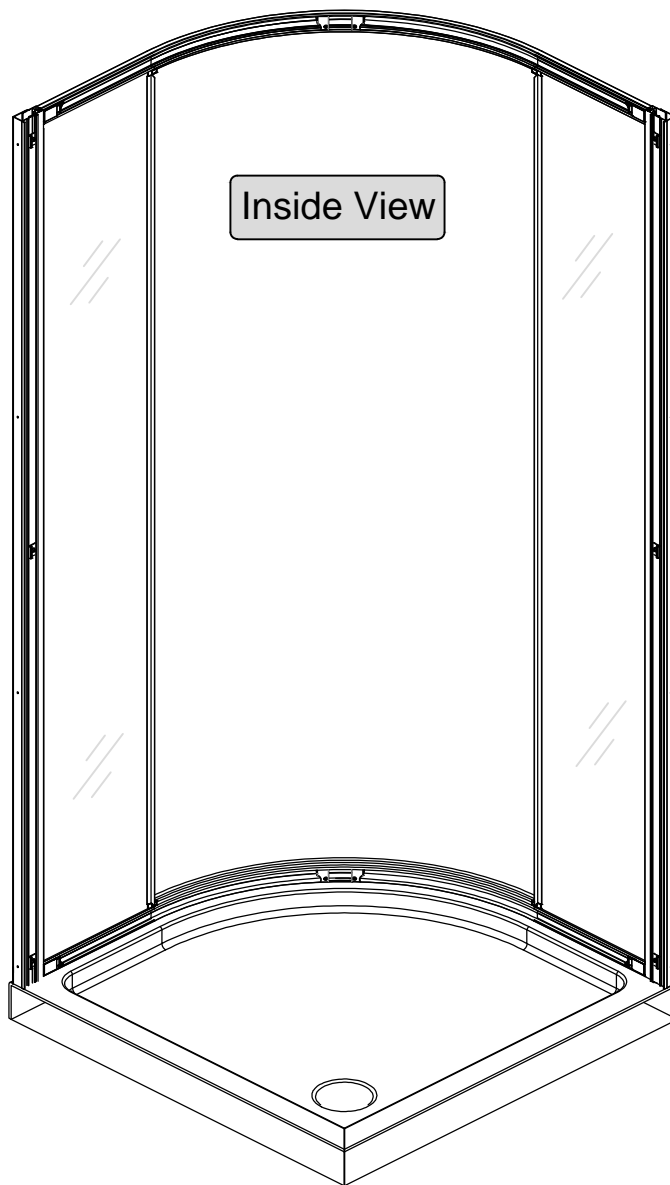
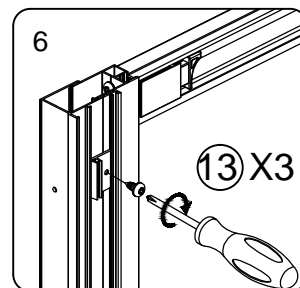
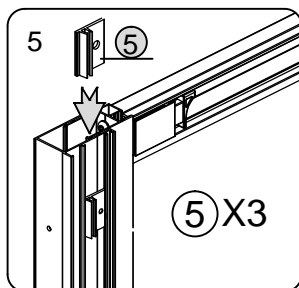
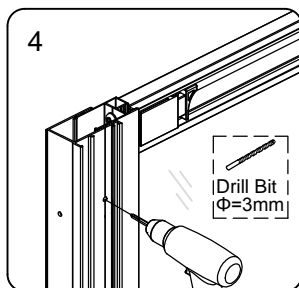
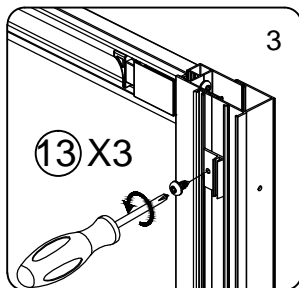
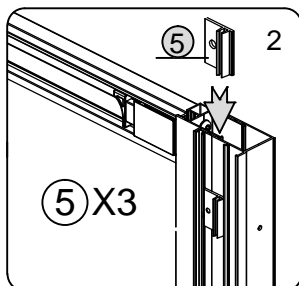
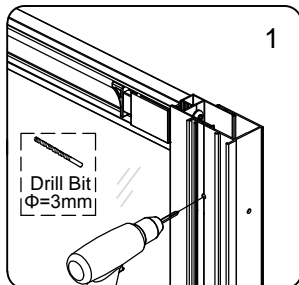

If you need further help please contact your local depot [www.ctb.co.uk](http://www.ctb.co.uk)



## Installation Quadrant Fit

Inside View

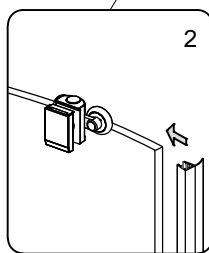
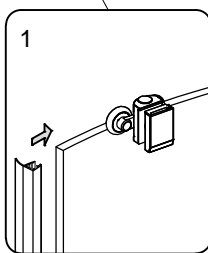
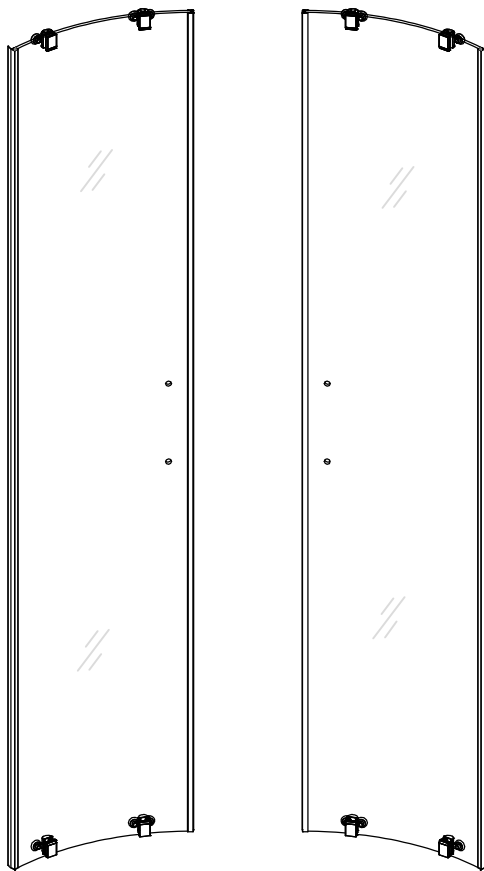

Tip:  
Push Door Seal In Door Glass,  
start from the bottom and work up.

If you need further help please contact your local depot [www.ctb.co.uk](http://www.ctb.co.uk)



## Installation Quadrant Fit

Tip:  
Locate bearing wheels on the top  
rail first.

Inside View

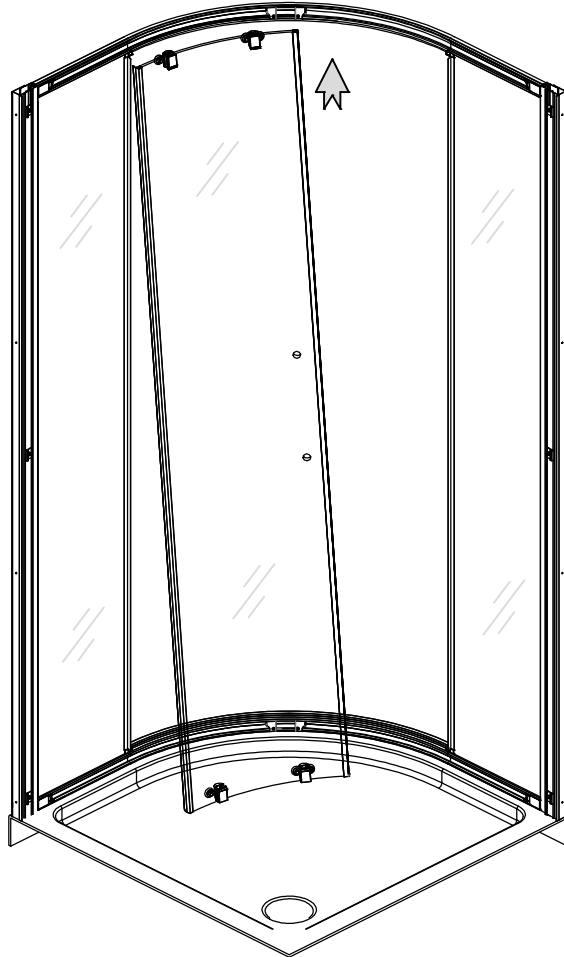

Bottom bearings are sprung loaded  
push them down so they fit into the  
bottom rail.

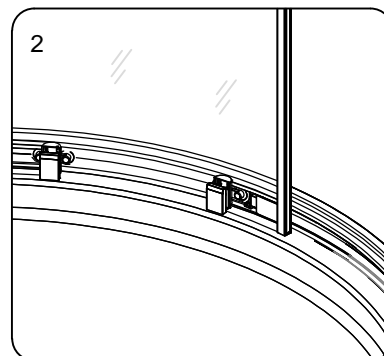
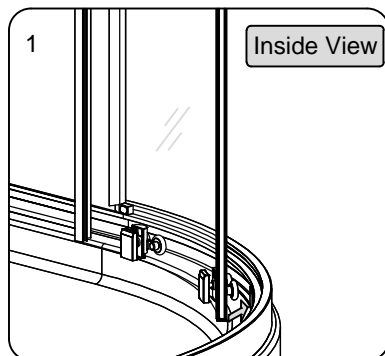

If you need further help please contact your local depot [www.ctb.co.uk](http://www.ctb.co.uk)

## Installation Quadrant Fit

! Handle Fitting See "Handle Installation"

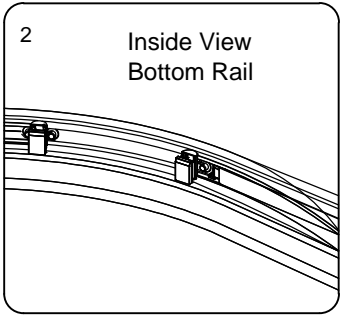
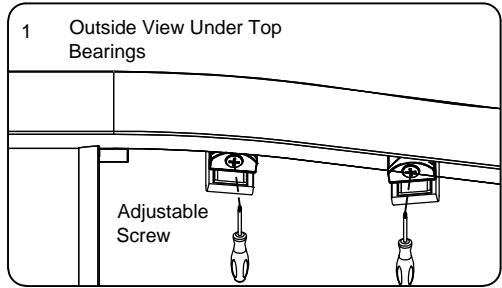
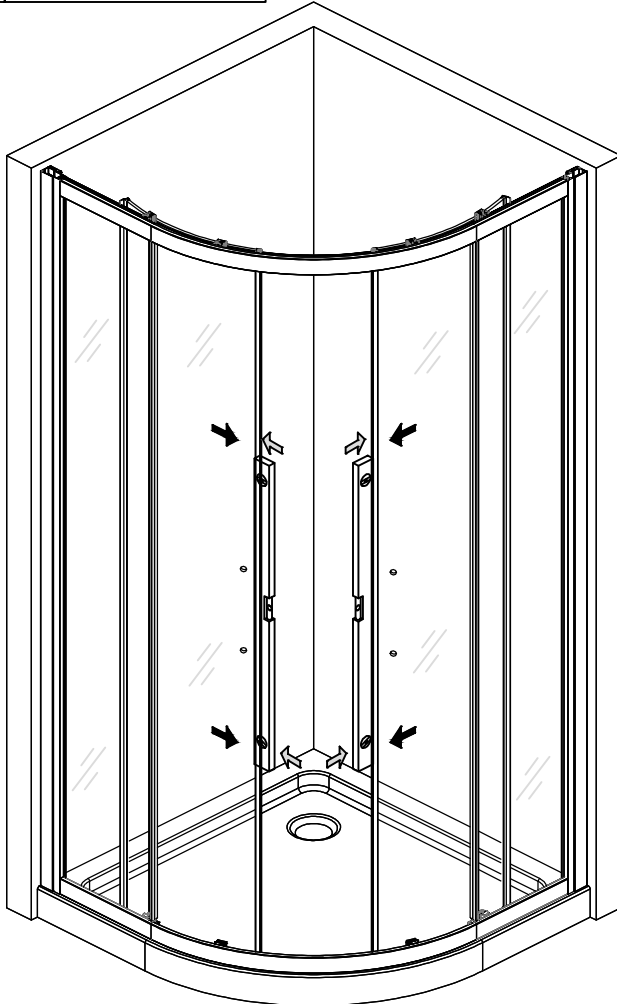

When door is correctly located, Door position can be levelled using the adjustment screws in the top rollers, please ensure doors run freely after adjustment.

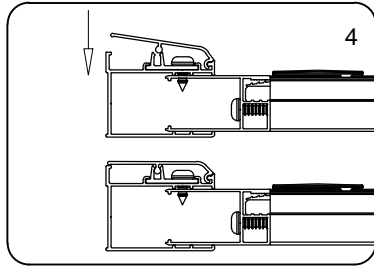
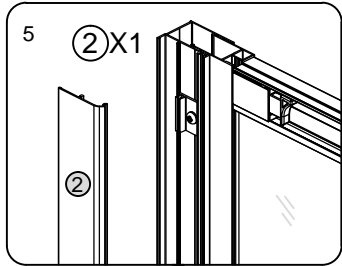
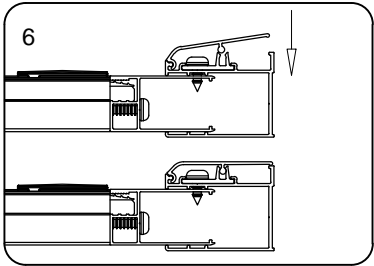
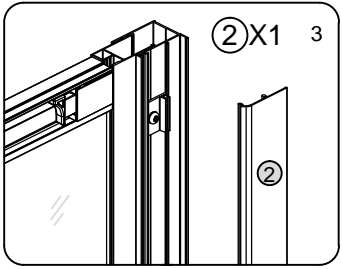

If you need further help please contact your local depot [www.ctb.co.uk](http://www.ctb.co.uk)



# Installation Quadrant Fit & Sealing

! Apply silicone between the fixed panel and the bottom rail.

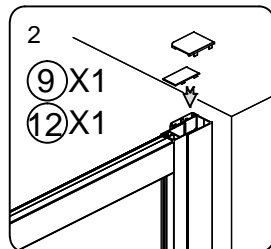
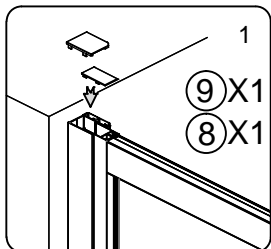
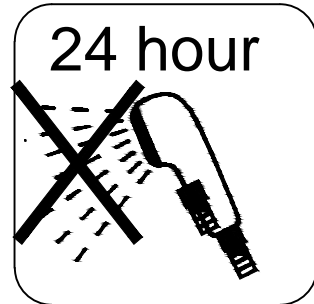
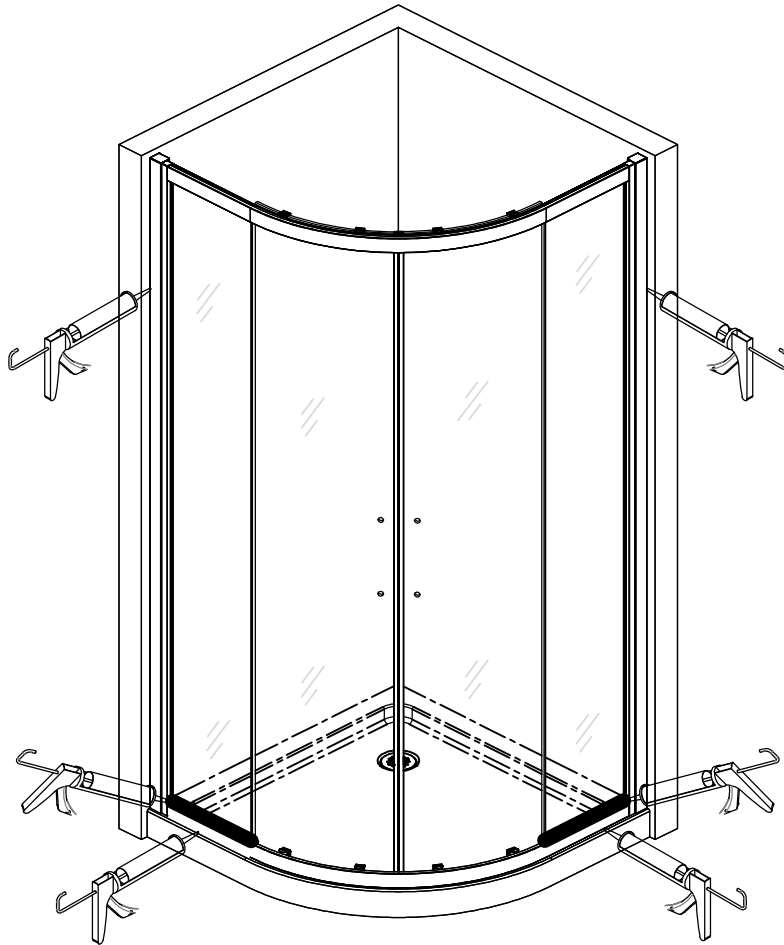

If you need further help please contact your local depot [www.ctb.co.uk](http://www.ctb.co.uk)