

INSTALLATION INSTRUCTION

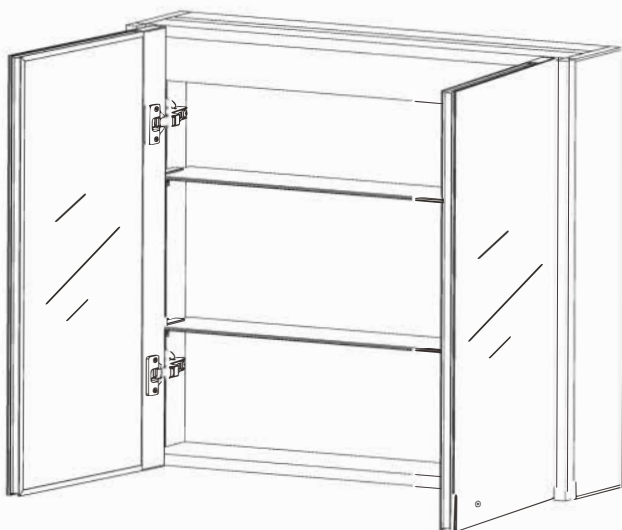

Wall Mounted Mirror Cabinet

- Adjustable stainless steel hinges
- Double layer adjustable tempered glass shelf
- Touch sensor switch
- Aluminum cabinet
- Double-sided copper-free silver mirror

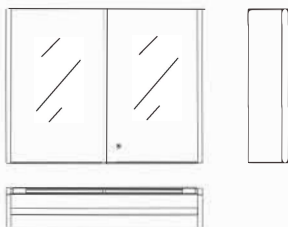

Note: Instructions for double door mirror cabinet (Applicable to sensor touch control)

Packing List

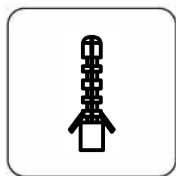

Wall Plugs $\varnothing 8$

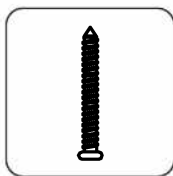

Screws M5

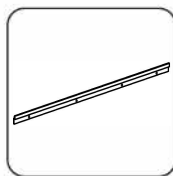

Wall Mounting Bracket

Required Tools

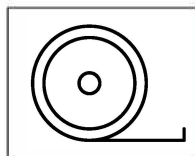

Tape Measure

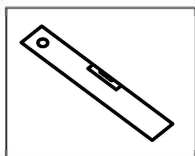

Spirit Level

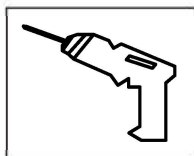

Electric Drill

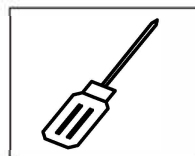

Screwdriver

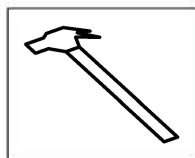

Hammer

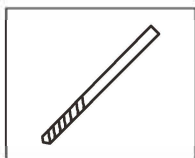

Drill Bit

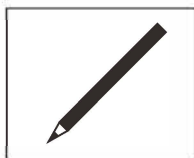

Pencil

Note: Please carefully read the following before installing



Warning

1. Turn off the main power switch.
2. This product requires that the installer has some electrical knowledge.
3. This mirror cabinet is heavy. We advise that 2 persons lift it into position.
4. Before installing, please check that the product is NOT damaged, to avoid injury caused by damaged glass.
5. Do not clean the product surface with acid and alkaline cleaning agent; please use a damp cloth.
6. In the event of a functional failure, do NOT attempt to dis-assemble or repair without authorisation. The company will NOT be responsible for any safety issues.

Installation Steps:

1. Wall Mounting Bracket

1.1 Select the location of the mirror cabinet and check that the wall is solid. Fixings are supplied but alternative fixings may be required depending on the type of wall the cabinet is to be fixed.

1.2 Measure the distance of the holes (A, A-1, A-2) in the mounting bracket with a tape measure and mark the wall with a pencil (Fig 1)
Ensure the mounting bracket is level.

1.3 Drill holes in the marked position with a drill and $\varnothing 8\text{mm}$ bit.
Use a ceramic drill bit if the wall surface is ceramic tiled.

1.4 Knock the wall plugs into the holes with a hammer, and fix with screws (Fig 2)



Fig. 1

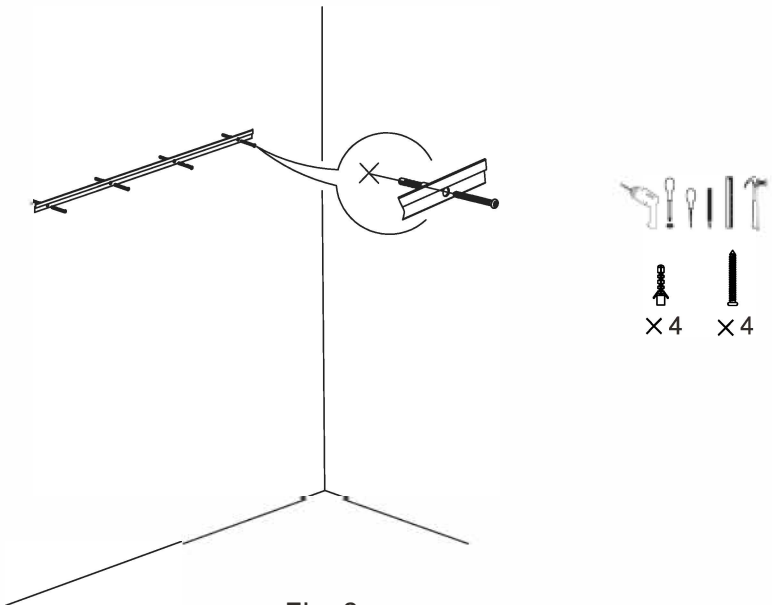

Fig. 2

2. Positioning and Installation of Mirror Cabinet:

2.1 Attach the mirror cabinet to the bar as shown in Fig. 3, open the cabinet door and mark on the wall with a pencil (Fig 4) through the back panel hole (a)

2.2 Remove the mirror cabinet, drill the fixing hole in the wall in the marked position, and place the expansion plugs (Fig. 5).

2.3 Repeat the operation as shown in Fig. 3 and mount the mirror cabinet onto the mounting bracket.

Ensure that the power is OFF before making any connection

2.4 Finally, turn on the main switch, and test to make sure switch works correctly.

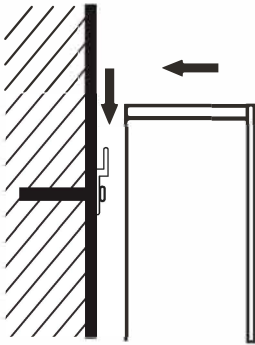

Fig. 3

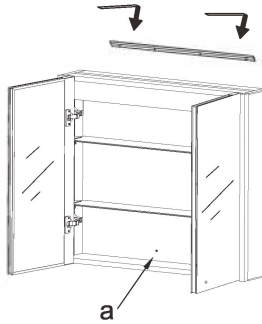

Fig. 4

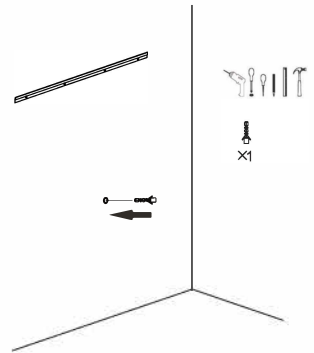

Fig. 5

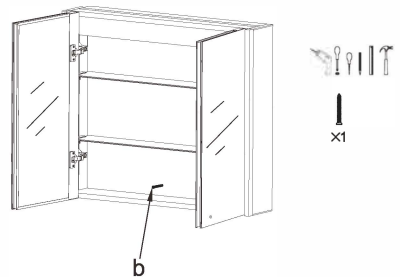
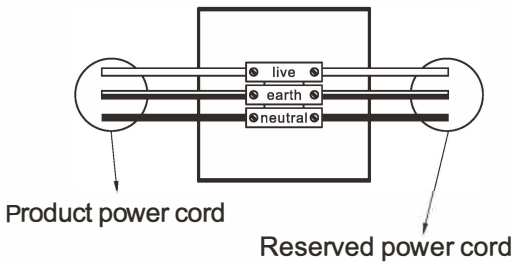
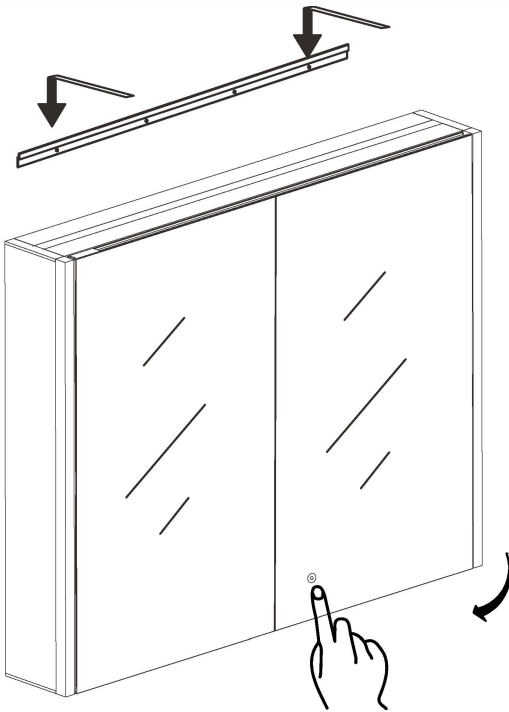

Fig. 6



Touch Sensor

3. Mirror Door Adjustment

3.1 Fix the mirror cabinet, and check if the mirror door is level.

If not adjust the distance of the door opening by adjusting the hinge screw (b) and level doors as in Fig 9.

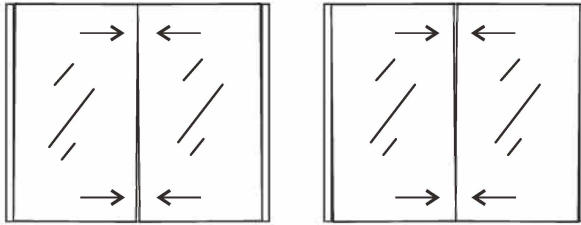
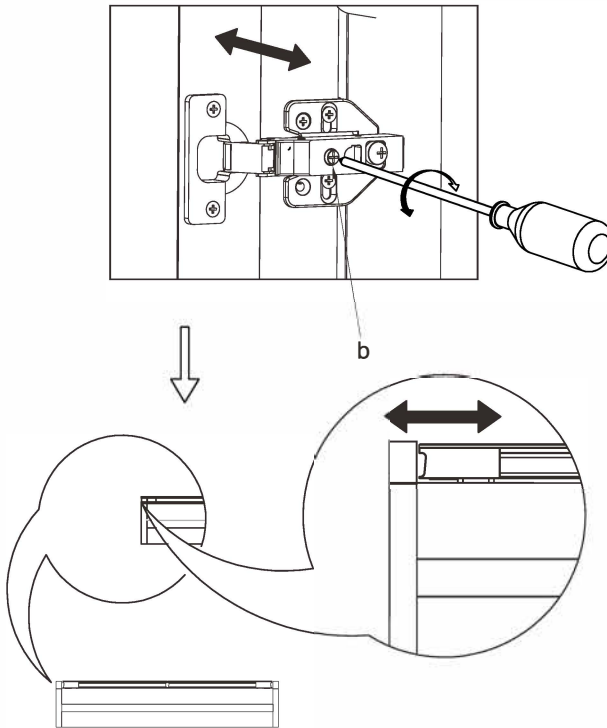

Fig. 8



Rotate CW: Door moves to the center of the mirror cabinet
Rotate CCW: Door moves to both sides of the mirror cabinet

Fig. 9

3.3 If the cabinet doors don't sit flat (Fig 10), adjust the distance between the door and the cabinet by adjusting the screw (c).

⚠ Warning: The distance between the door and the cabinet should not be too small, otherwise the doors may bind.

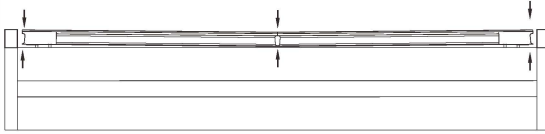
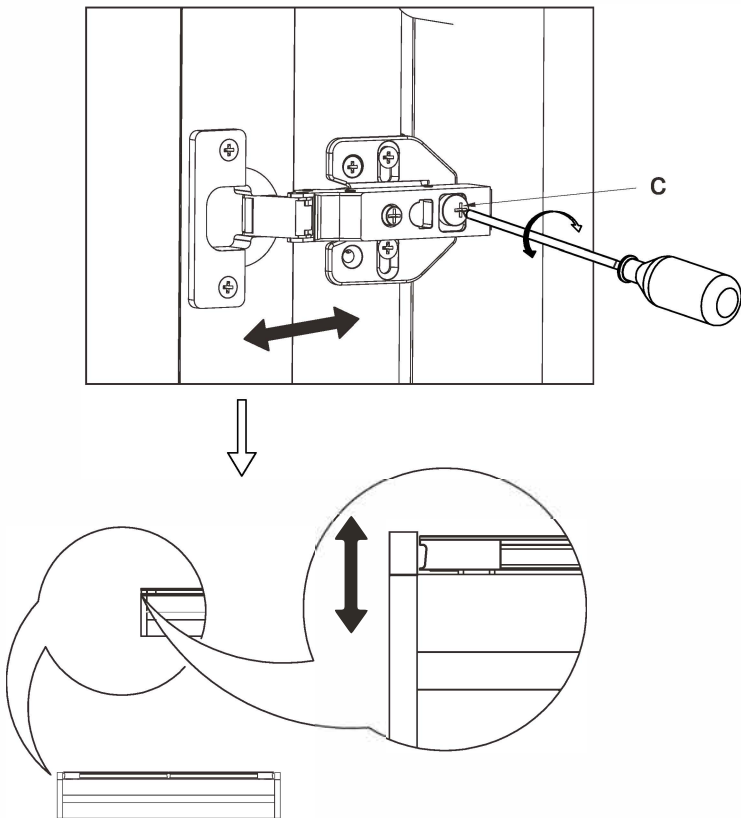

Fig. 10



Rotate CW: Distance between door and cabinet reduces
Rotate CCW: Distance between door and cabinet increases

Fig. 11

4. Loosen screw (d) to adjust the shelf positions as in Fig 12.

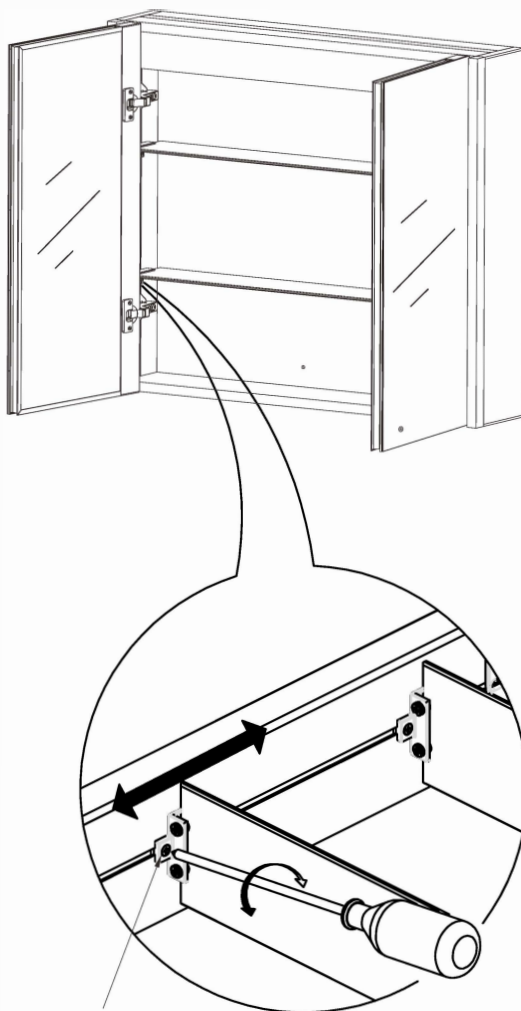

Safety Warning

Fig. 12

- Do not disassemble the door unless necessary